

# HP Storage Management Pack for System Center User Guide

## Abstract

This guide provides information about HP Storage Management Pack for System Center Operations Manager.

HP Part Number: 5697-3491  
Published: October 2014  
Edition: 19



© Copyright 2004, 2014 Hewlett-Packard Development Company, L.P.

Confidential computer software. Valid license from HP required for possession, use or copying. Consistent with FAR 12.211 and 12.212, Commercial Computer Software, Computer Software Documentation, and Technical Data for Commercial Items are licensed to the U.S. Government under vendor's standard commercial license.

The information contained herein is subject to change without notice. The only warranties for HP products and services are set forth in the express warranty statements accompanying such products and services. Nothing herein should be construed as constituting an additional warranty. HP shall not be liable for technical or editorial errors or omissions contained herein.

Microsoft® and Windows® are U.S. registered trademarks of Microsoft Corporation.

HP Storage Management Pack 4.1 for System Center User Guide.

---

# Contents

<b>1 Understanding Management Pack.....</b>	<b>7</b>
New features in version 4.1.....	7
Selecting an Event Delivery method.....	7
Using Event Flow model.....	7
Using WEBES.....	8
Using SNMP.....	8
Using WMI.....	9
<b>2 Installing Management Pack.....</b>	<b>11</b>
System requirements for installation.....	11
Product support.....	11
Installation prerequisites for HP Storage Management Pack.....	12
Installing OpsMgr.....	12
Installing SNMP.....	13
SNMP Support Matrix.....	13
Pre-installation setup activities for SNMP.....	13
Installing the SNMP software.....	13
Installing WEBES/SEA.....	14
WEBES Support Matrix.....	14
Configuring WEBES to send an XML event callout.....	14
Sending event messages.....	15
Installing WMI.....	15
WMI Support Matrix.....	15
Installing WMI.....	15
Installing the Management Pack software.....	15
HP Storage Management Pack for System Center.....	16
Installing the HP Storage Management Pack software.....	16
Upgrading HP Storage Management Pack for System Center.....	22
Modifying the HP Storage Management Pack software.....	23
Repairing the HP Storage Management Pack software.....	26
Uninstalling HP Storage Management Pack for System Center.....	29
Silently installing HP Storage Management Pack for System Center.....	32
Silently modifying HP Storage Management Pack for System Center.....	33
Silently repairing HP Storage Management Pack for System Center.....	33
Silently uninstalling HP Storage Management Pack for System Center.....	34
HP Storage WEBES Listener for System Center.....	34
WMI Listener in OpsMgr.....	34
Installing WEBES Listener on WEBES collection point systems.....	34
Repairing the HP Storage WEBES Listener for System Center.....	39
Uninstalling HP Storage WEBES Listener for System Center.....	41
Silently installing HP Storage WEBES Listener for System Center.....	43
Silently repairing HP Storage WEBES Listener for System Center.....	44
Silently uninstalling HP Storage WEBES Listener for System Center.....	44
Discovery of HP Storage devices using HP Storage Management Pack User Configuration Tool.....	44
Discovering HP Storage devices in the HP Storage Management Pack User Configuration Tool.....	44
Modifying credentials of HP Storage devices in HP Storage Management Pack user configuration tool.....	48
Removing discovered HP Storage device from the HP Storage Management Pack user configuration tool.....	49
Configuring the Management Pack for HP 3PAR StoreServ Storage.....	50
Processing Events/Alerts for HP 3PAR StoreServ Storage.....	50
Diagram View of the HP 3PAR StoreServ Storage.....	51

Capacity Dashboard for HP 3PAR StoreServ Storage.....	55
Tabular representation of Capacity Summary.....	56
Graphical representation of Capacity Summary.....	57
Health Dashboard for HP 3PAR StoreServ Storage.....	58
Health Summary.....	59
Alert Summary.....	60
Accessing Capacity Dashboard from a remote OpsMgr Console.....	61
Configuring the Management Pack for HP StoreVirtual Storage.....	62
Processing Events/Alerts for HP StoreVirtual Storage.....	62
Diagram View of the HP StoreVirtual Storage.....	62
Configuring the Management Pack for HP 3PAR StoreServ File Controller.....	64
Processing Events/Alerts for HP 3PAR StoreServ File Controller.....	64
Diagram View of the HP 3PAR StoreServ File Controller.....	65
Configuring the Management Pack for HP P2000 MSA Storage.....	67
Processing Events/Alerts for HP P2000 MSA Storage.....	67
Diagram View of the HP P2000 MSA Storage.....	68
Configuring the Management Pack for HP StoreEasy 5000 Storage.....	71
Processing Events/Alerts for HP StoreEasy 5000 Storage.....	71
Diagram View of the HP StoreEasy 5000 Storage.....	73
Configuring the Management Pack for HP StoreEasy 1000 and HP StoreEasy 3000 Storage.....	75
Processing Events/Alerts for HP StoreEasy 1000 and HP StoreEasy 3000 Storage.....	75
Configuring the Management Pack for HP XP 9000 Storage.....	76
Processing Events/Alerts for HP XP 9000 Storage .....	76
Configuring the Management Pack for HP EVA P6000.....	78
Processing Events/Alerts for HP EVA P6000 Storage .....	78
Configuring the Management Pack for HP StoreOnce Backup.....	78
Processing Events/Alerts for HP StoreOnce Backup .....	78
Configuring the Management Pack for HP E5000 Messaging System.....	80
Processing Events/Alerts for HP E5000 Messaging System.....	80
Diagram View of the HP E5000 Messaging System .....	81
Configuring the Management Pack for HP StoreEver Tape Libraries.....	82
Processing Events/Alerts for HP StoreEver Tape Libraries.....	82
<b>3 Configuration for monitoring device.....</b>	<b>84</b>
SNMP.....	84
Configuration of SNMP service.....	84
Configuration of OpsMgr Server to process SNMP traps.....	86
Getting SNMP Traps from HP 3PAR StoreServ Storage.....	86
Getting SNMP traps from HP StoreVirtual Storage System.....	87
Enabling an SNMP agent.....	87
Adding an SNMP client.....	87
Enabling SNMP traps.....	88
Getting SNMP traps from HP P2000 MSA Storage.....	88
Monitoring SNMP traps for MSA 1000 and 1500 series arrays.....	88
Monitoring SNMP traps for P2000 series arrays.....	88
Getting SNMP traps from HP StoreOnce Backup.....	89
Adding an SNMP trap destination.....	89
Editing an SNMP trap destination.....	89
Removing an SNMP trap destination.....	89
Getting SNMP traps from HP XP 9000.....	90
Getting SNMP traps from HP StoreEver Tape Libraries.....	90
Adding an SNMP trap.....	90
Editing an SNMP trap.....	90
Removing an SNMP trap.....	91
WEBES Events.....	91

Monitoring WEBES.....	91
Generating WEBES test event.....	91
Viewing events using Windows.....	91
Interpreting WEBES messages.....	93
WMI events.....	95
Understanding HP E5000 Messaging System/HP StoreEasy 5000 Storage System configuration.....	95
Discovery of HP E5000 Messaging System.....	95
Discovery of HP StoreEasy 5000 Storage.....	103
Getting WMI Events from HP E5000 Messaging System/HP StoreEasy 5000 Storage.....	103
Discovery of HP StoreEasy 1000 and HP StoreEasy 3000 Storage.....	103
Discovery of HP 3PAR StoreServ File Controller.....	103
Getting WMI Events from HP 3PAR StoreServ File Controller.....	104
<b>4 Using the Management Pack software.....</b>	<b>105</b>
View Discovered Inventory.....	105
Disabling Discoveries.....	109
Monitoring HP Services Health.....	111
Service Health Monitors.....	111
HP P6000 Command View Service Health Monitor.....	112
HP Storage SMI-S CIM Service Health Monitor.....	112
HP WEBES DESTA Service Health Monitor.....	112
HP WEBES DESTA WCCProxy Service Health Monitor.....	112
Monitoring console.....	113
Event handling.....	113
Events Details tab.....	113
Event Parameters.....	113
Using OpsMgr Views.....	114
HP Storage.....	114
HP 3PAR StoreServ Storage warnings and errors.....	114
HP 3PAR StoreServ File Controller.....	114
HP StoreEver Tape Libraries warnings and errors.....	114
HP StoreVirtual Storage System.....	115
HP P6000 Command View EVA Software Suite.....	115
HP EVA P6000 Storage.....	115
HP P2000 MSA Storage Arrays.....	115
HP XP 9000 Storage.....	115
HP Web-Based Enterprise Services (WEBES).....	115
HP StoreOnce Backup.....	115
HP E5000 Messaging System.....	115
HP StoreEasy 5000 System.....	115
HP StoreEasy 1000 Storage.....	115
HP StoreEasy 3000 Storage.....	115
Alerts.....	115
Alert Details tab.....	115
Product Knowledge tab.....	116
Alerts and views.....	116
HP Storage.....	116
HP StoreEver Tape Libraries warnings and errors.....	117
HP 3PAR StoreServ Storage warnings and errors.....	117
HP StoreVirtual Storage warnings and errors.....	117
HP P6000 Command View EVA Software Suite warnings and errors.....	117
HP EVA P6000 Storage warnings and errors.....	117
HP P2000 MSA Storage Array warnings and errors.....	117
HP XP 9000 Storage warnings and errors.....	117

HP Web-Based Enterprise Services (WEBES) warnings and errors.....	117
HP StoreOnce Backup warnings and errors.....	117
HP E5000 Messaging System warnings and errors.....	117
HP StoreEasy 5000 Storage warnings and errors.....	117
HP StoreEasy 1000 Storage.....	117
HP StoreEasy 3000 Storage.....	117
HP 3PAR StoreServ File Controller.....	118
<b>5 Using HP Storage Management Pack PowerShell Cmdlets.....</b>	<b>119</b>
Prerequisites.....	119
Using HP Storage Management Pack PowerShell Cmdlets.....	119
List of PowerShell Cmdlets for HP Storage Management Pack.....	119
<b>6 Frequently Asked Questions.....</b>	<b>121</b>
HP Systems Insight Manager.....	121
Platform Support.....	121
Known Behavior.....	122
Troubleshooting.....	122
Installer .....	122
SNMP.....	123
Diagram View.....	123
Collection Point Server.....	123
Dashboards.....	124
Devices.....	124
HP 3PAR StoreServ.....	124
HP P2000 MSA.....	125
HP EVA P6000.....	126
E5000 / HP StoreEasy 5000.....	127
HP StoreEver Tape Library.....	128
Miscellaneous.....	128
<b>7 Support and other resources.....</b>	<b>129</b>
Intended audience.....	129
Related documentation.....	129
Document conventions and symbols.....	129
HP technical support.....	130
HP-authorized reseller.....	130
Helpful websites.....	130
Support Information.....	131
<b>Glossary.....</b>	<b>132</b>
<b>Index.....</b>	<b>133</b>

# 1 Understanding Management Pack

This chapter introduces you to the concepts of HP Storage Management Pack. The HP Storage Management Pack for System Center is designed to receive alerts, events, topology, capacity, and health information from the HP Storage portfolio. This information will be shown in Operations Manager under different views.

## New features in version 4.1

The HP Storage Management Pack for System Center 4.1 release supports the following:

- Components in diagram view for HP StoreVirtual Storage is grouped under Physical, Logical and Virtual groups. Following components are added:

**Table 1**

Component Type	Component Group Name
Physical	HP StoreVirtual Appliance
Logical	Volumes and Snapshot
Virtual	HP StoreVirtual Virtual Storage Appliance

**NOTE:**

The previous version of HP StoreVirtual Storage Management Pack for System center must be removed from the OpsMgr console. For more information see [Installation prerequisites](#)

## Selecting an Event Delivery method

The table below lists storage environments and associated event delivery methods.

**Table 2 Event Delivery Methods**

Storage Environment	Event Delivery Method
HP 3PAR StoreServ Storage, HP P2000 MSA Storage, HP StoreVirtual Storage, HP XP 9000 Storage, HP StoreEver Tape Library, and HP StoreOnce Backup	SNMP
HP application service health	OpsMgr Agent should be installed on same server as the Application
EVA P6000 and CV EVA with (WEBES/SEA 6.1, 6.2, or 6.3)	WEBES
HP E5000 Messaging System , HP StoreEasy 5000 Storage, HP StoreEasy 1000 and HP StoreEasy 3000 Storage, HP 3PAR StoreServ File Controller	OpsMgr Agent must be installed on E5000 Messaging System, HP StoreEasy 5000, HP StoreEasy 1000 and HP StoreEasy 3000 Storage, HP 3PAR StoreServ File Controller as part of a manual discovery to subscribe and listen to WMI events.

**NOTE:** If you are using the XML event delivery method, the TCP port is automatically unblocked with any variant of Microsoft Windows Server 2003 with Service Pack 1. The default port number is 8945.

## Using Event Flow model

**NOTE:** Before you install the software, you must plan the deployment. Depending on the types of storage products you are using, you must identify the locations where you want to install and run the various management components.

## Using WEBES

In the WEBES Event Flow model, you need two to four systems to configure events to flow from the Storage Device Manager (HP P6000 Command View) to System Center. The following figure shows the WEBES Event Flow model:

**Figure 1 WEBES event flow model**

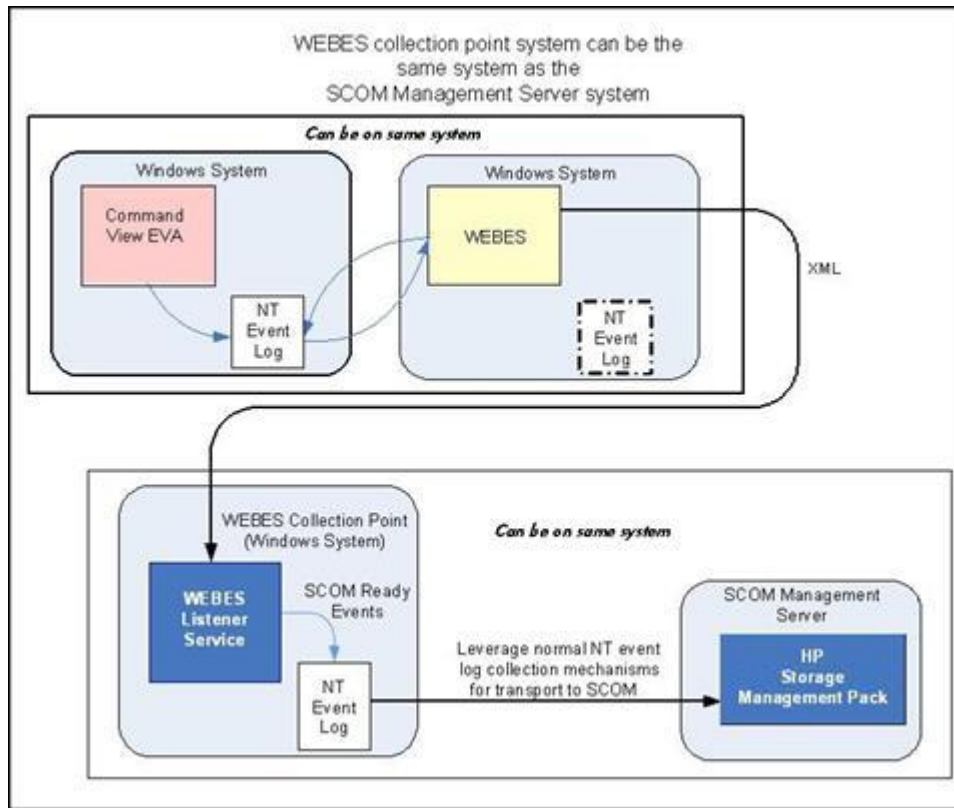

**NOTE:** WEBES and the WEBES Listener (on a WEBES Collection Point) cannot simultaneously run on the same system. However, all other permutations, including configuration of the OpsMgr Server as a WEBES Collection Point, are supported.

For more information related to WEBES, see ["Installing Management Pack" \(page 11\)](#).

## Using SNMP

In the SNMP Event Flow model, you need one to three systems to configure events to flow from the Storage Device Manager (Command View Tape Library software or equivalent) to System Center. These functions can run on the OpsMgr Server, or can be distributed as required throughout your environment. [Figure 2 \(page 9\)](#) shows the SNMP Event Flow model for HP 3PAR StoreServ Storage, HP StoreVirtual Storage, HP StoreOnce Backup, HP XP 9000 Storage, HP P2000 MSA Storage, and HP StoreEver Tape Libraries. For more information related to SNMP, see ["Installing Management Pack" \(page 11\)](#).



**Figure 2 SNMP event flow model**

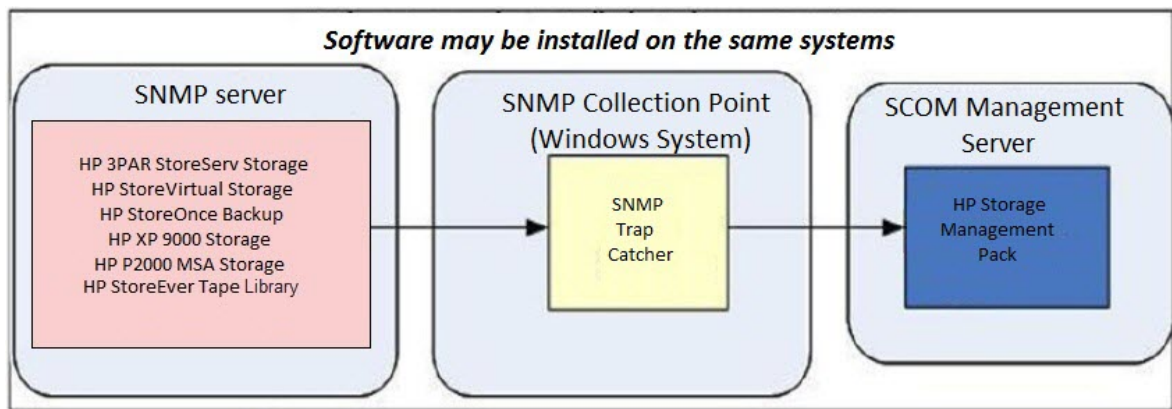

---

**NOTE:** When using SNMP collection points, the HP Storage Management Pack should be installed on collection point server where the OpsMgr agent is deployed.

---

## Using WMI

In the WMI (Windows Management Instrumentation) event flow model, for configuring events to flow from the device to System Center, the device must be discovered from OpsMgr and the agent must be installed on HP E5000 Messaging System, HP StoreEasy 5000 Storage, HP StoreEasy 1000 Storage, HP StoreEasy 3000 Storage, and HP 3PAR StoreServ File Controller.

At a given time, you can work with only one blade server in an E5000 System/HP StoreEasy 5000 Storage. Discovering more than one blade servers within an E5000 System/HP StoreEasy 5000 Storage System may result in duplicate events being reported by the System Center. If the blade server fails, the administrator needs to discover another E5000/HP StoreEasy 5000 Storage blade server. The E5000 Messaging System/HP StoreEasy 5000 Storage/HP StoreEasy 1000 Storage/HP StoreEasy 3000 Storage/HP 3PAR StoreServ File Controller must be in a healthy state in the operations console to enable monitoring.

For more information related to WMI, see [“Installing Management Pack” \(page 11\)](#).

[Figure 3 \(page 10\)](#) shows the WMI Event Flow model:

Figure 3 WMI event flow model

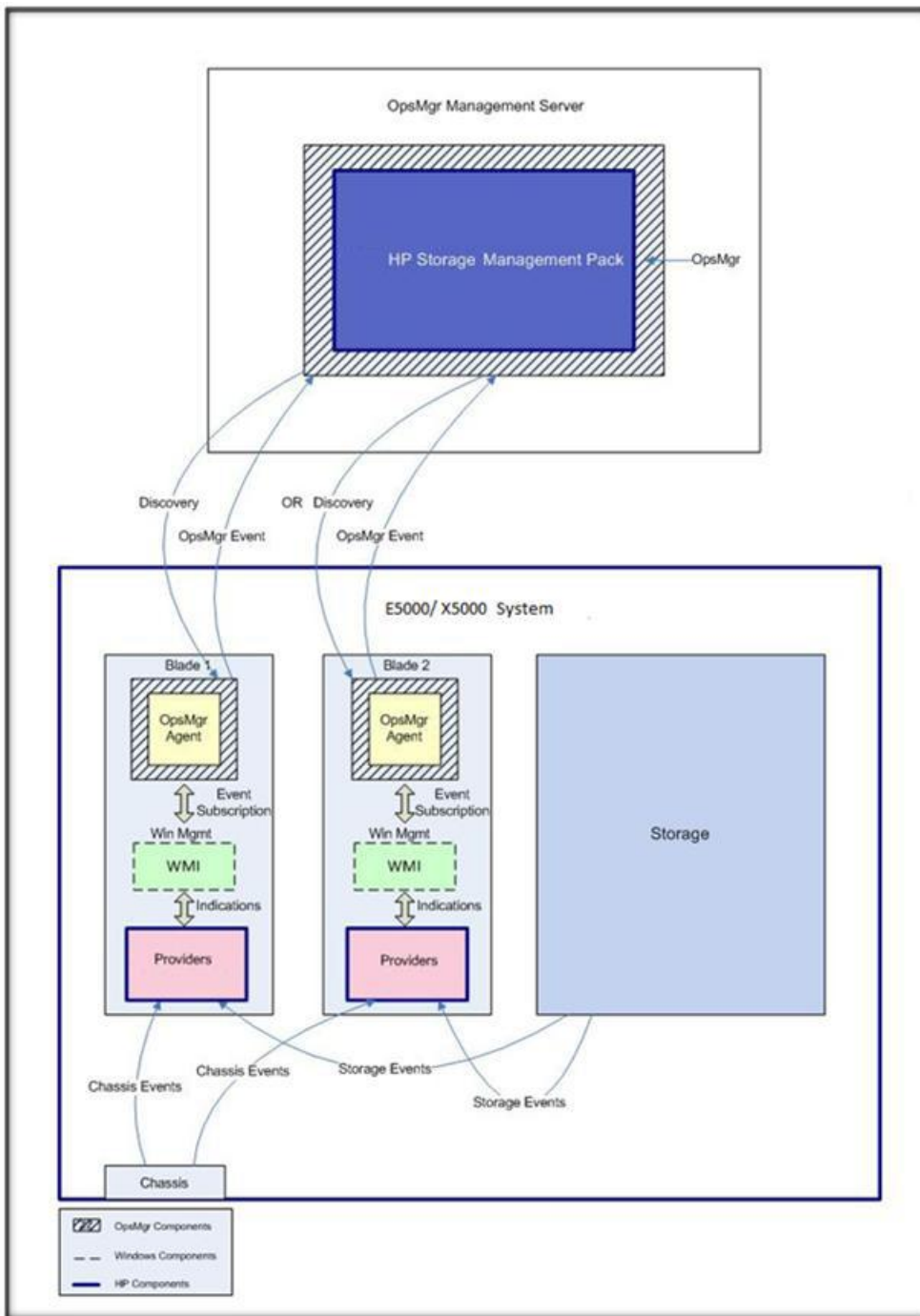

**NOTE:** The HP Storage Management Pack supports events only from the chassis and storage components of E5000 Messaging System and HP StoreEasy 5000 Storage.

For more information on how to monitor events from blade servers in an E5000 Messaging System, see the E5000 Messaging System product documentation.

For more information on how to monitor events from blade servers in an HP StoreEasy 5000 Storage, see the HP StoreEasy 5000 Storage product documentation.

## 2 Installing Management Pack

This chapter describes how to install the HP Storage Management Pack in your storage environment, along with other System Software.

### System requirements for installation

**Hardware Requirements:** There are no specific hardware requirements for Management Pack. It will be installed as a plug-in over the System Center. The HP Storage Management Pack can be installed on the collection points where only OpsMgr agents are deployed and OpsMgr is not installed.

**OS Support:** The following Operating Systems are supported for HP Storage Management Pack installation on the Operations Manager Server:

**Table 3**

Operating System	Language Supported
Microsoft Windows Server 2012 R2	English and Japanese
Microsoft Windows Server 2012	English
Microsoft Windows Server 2008 R2 SP1 Standard and Enterprise edition	English
Microsoft Windows Server 2008 R2 Standard and Enterprise edition	English
Microsoft Windows Server 2008 Standard and Enterprise edition (x64 and x86)	English
Microsoft Windows Server 2003 Standard and Enterprise edition (x64)	English

Collection Point installation of HP Storage Management Pack is supported on all the operating systems that are supported by SCOM.

### Product support

The HP Storage Management Pack supports the following Storage Devices:

- HP Storage ESL E-Series, EML E-Series, ESL 6000/9000/12000, and MSL Series
- HP XP 9000 Storage
- HP EVA P6000 Storage
- HP P2000 MSA Storage
- HP E5000 Messaging System
- HP StoreEasy 5000 Storage
- HP 3PAR StoreServ Storage
- HP StoreOnce Backup System
- HP StoreEasy 1000 and HP StoreEasy 3000 Storage
- HP StoreVirtual Storage (both Appliance and VSA)
- HP 3PAR StoreServ File Controller

# Installation prerequisites for HP Storage Management Pack

Table 4 (page 12) lists the software components that you must install before installing the HP Storage Management Pack.

**Table 4 Installation prerequisites**

Software	Location of software
.NET Framework 3.0, 3.5, 4.1, and 4.5 depending on the operating system	It is the system where OpsMgr is installed. It can also be installed on a machine which acts as a collection point with the agent installed on it.
OpsMgr	It is on the Windows Server.
WEBES/SEA (System Event Analyzer)	It is in your storage environment. For more information, see <a href="#">Installing WEBES/SEA</a>
SNMP Service	It is in your storage environment. For more information, see “ <a href="#">Installing SNMP</a> ” (page 13).
WMI Service	It runs on the E5000/StoreEasy 5000 blade/ StoreEasy 1000/StoreEasy 3000 servers/HP 3PAR StoreServ File Controller. For more information, see <a href="#">Installing WMI</a>
Windows Power Shell v2.0 or v3.0	It is on both OpsMgr and Collection Point servers, where HP Storage Management Pack is installed.
SMI-S Service	It is on HP 3PAR StoreServ Storage and on HP P2000 MSA Storage. Ensure that in the http mode, the SMI-S service is running on the 5988 port .
SCVMM Console 2012 R2	It is the system where OpsMgr 2012 R2 is installed, to display Virtual Machine information in Diagram view for HP 3PAR StoreServ Storage
HP Storage UI Add-in 2.0 or later for SCVMM	Install the Server Module of HP Storage UI Add-in on the SCVMM management server. For more information, see <a href="#">HP Storage UI Add-in</a>

**NOTE:**

- Installation will require permission of an administrator. User should be logged in as a member of Local Administrator or Domain Administrator Group.
- If OpsMgr server is part of Network Resource Pool, then it is recommended have a collection point server to receive events. For more information, see “[Known Behavior](#)” (page 122).

## Installing OpsMgr

You must install and configure OpsMgr Management and Console server before installing the HP Storage Management Pack.

To download OpsMgr 2007 R2, visit the following website:

<http://www.microsoft.com/systemcenter/opsmgr/>

To download OpsMgr 2012 and OpsMgr 2012 SP1, visit the following website:

<http://www.microsoft.com/en-us/server-cloud/system-center/datacenter-management.aspx>

To download OpsMgr 2012 R2, visit the following website:

<http://www.microsoft.com/en-us/server-cloud/products/system-center-2012-r2>

## Installing SNMP

To enable event flow to OpsMgr through SNMP, you must install the SNMP Trap Catcher Service on the system or systems you have chosen to be your SNMP collection points. A collection point can be the same system on which your OpsMgr software is installed.

Figure 2 (page 9) shows the flow of events using SNMP.

## SNMP Support Matrix

You must first install SNMP if you have the following software installed in your environment:

- HP Storage ESL E-Series, EML E-Series, ESL 6000/9000/12000, and MSL Series
- HP 3PAR StoreServ Storage
- HP StoreVirtual Storage LeftHand OS v9.5, v10.5, and v11.0 (formerly known as SAN/iQ)
- HP XP 9000 Storage
- HP P2000 MSA Storage
- HP StoreOnce Backup

## Pre-installation setup activities for SNMP

Your system consists of an OpsMgr Server and one or more agents. If the system is directly monitored by root management servers, the agent installation is not required. The agents are listed in the **Computers** tab of the Administrator console in the OpsMgr Server. You can add new agents using the **Discovery wizard** in the OpsMgr Administrator Console. You must install the SNMP Trap Catcher Service on all agents before you start sending SNMP messages to the agents.

## Installing the SNMP software

If your SNMP and OpsMgr Server is installed on the same system, you must install the SNMP WMI Provider and ensure that `snmp` and `snmptrap` services are running.

Complete the following steps to install the SNMP WMI Provider for Microsoft Windows Server 2012 or later:

1. Launch **Server Manager**.
2. Click **Manage** on the Server Manager Dashboard page.
3. Select **Add Roles and Features**.
4. Select **Features** and expand the SNMP service on the right pane.
5. Select the required SNMP service and SNMP WMI Provider. Click **Next**. A confirmation page appears to verify the selection.
6. Click **Install**. The installation wizard starts.
7. Click **Close** to complete the installation.

Complete the following steps to install the SNMP WMI Provider for Microsoft Windows Server 2008:

1. Double-click **Administrative Tools+Server Manger**.
2. Click **Features** on the Server Manager page.
3. Click **Add Features**, the Add Features Wizard appears.
4. Select **Features** and expand the SNMP Services on the right pane.
5. Select the required SNMP Service and SNMP WMI Provider. Click **Next**. A confirmation page appears to verify the selection.
6. Click **Install**. The installation wizard starts.
7. Click **Close** to complete the installation.

Complete the following steps to install the SNMP WMI Provider for Microsoft Windows Server 2003:

1. Open the Windows **Control Panel**.
2. Double-click **Add/Remove Programs**.
3. Click **Add/Remove Windows Components**.
4. Select the **Management and Monitoring tools** option from the **Windows Components Wizard** window.  
Click **Details**.
5. Select **Simple Network Management Protocol** and **WMI SNMP Provider**.  
Click **OK**.
6. Click **Next** to install the selected options on the **Windows Components Wizard** window. The installation wizard starts.
7. Click **Finish** to complete the installation.

## Installing WEBES/SEA

### WEBES Support Matrix

You must first install WEBES/SEA if you have HP Storage P6000/Enterprise Virtual Array 4x00/6x00/8x00, P6300, P6500, and associated HP Command View device management software installed in your storage environment.

---

**NOTE:** If WEBES/SEA 6.1, 6.2 or 6.3 is available, you can configure MOM alerts in WEBES and receive EVA alerts in SCOM, else monitoring of EVA alerts is not supported.

---

### Configuring WEBES to send an XML event callout

WEBES sends XML callout information when it receives a EVA P6000 event notification only from an HP storage device. WEBES/SEA analyzes this event and generates an XML event callout report, and sends it to the Management Pack XML Event Listener.

To configure WEBES/SEA to send an XML event callout to a particular host port pair where the WEBESEventListener service is listening, complete the following steps on the WEBES/SEA installed host:

1. Start the WEBES **desta** service at the command line using `desta start`. You can also start the service from the Windows **Start** menu.
2. Enable OpsMgr support, by entering the following command: `desta mom on`  
The system prompts you to enter host name and port of the system where you want to send the XML callout information.

---

**NOTE:** Turning **desta mom** OFF and ON displays the OpsMgr node name (IP address).

---

For more information about installing and configuring WEBES/SEA, see the following website:

<http://h18023.www1.hp.com/support/svctools/webes/>

---

**NOTE:** If you want to change the default TCP port number (8945), enter the new port number. After you install the WEBES Listener, change the port number in the `config.txt` file located in the `C:\Program Files\HP\HP Storage WEBES Listener for System Center` directory for a 32-bit operating system, and `C:\Program Files(x86)\HP\HP Storage WEBES Listener for System Center` directory for a 64-bit operating system. Stop and restart the WEBES Listener service.

For more information, see [Figure 4 \(page 15\)](#)

#### Figure 4 Enabling OpsMgr within WEBES



```
Q:\WINDOWS\system32\cmd.exe
Microsoft Windows [Version 5.2.3790]
(C) Copyright 1985-2003 Microsoft Corp.

Q:\Documents and Settings\administrator.STSDCLX>desta mom on
What is the name of the MOM node [10.2.3.4]: 9745
What is the port number the MOM is listening on [8945]: <port-number>

Q:\Documents and Settings\administrator.STSDCLX>_
```

---

## Sending event messages

WEBES (6.1, 6.2, and 6.3) sends event messages through XML report to a particular host and port.

## Installing WMI

### WMI Support Matrix

To receive the events from HP E5000 Messaging System, HP StoreEasy 5000 , HP StoreEasy 1000, HP StoreEasy 3000 Storage, and HP 3PAR StoreServ File Controller WMI service should be running on both the systems.

### Installing WMI

WMI is installed by default in the supported operating systems.

For more information on the HP E5000 Messaging System, see <http://www.hp.com/go/E5000>.

For more information on the HP StoreEasy 5000 , HP StoreEasy 1000 and HP StoreEasy 3000 Storage, see <http://www8.hp.com/us/en/products/file-object-storage/index.html>

For more information on the HP 3PAR StoreServ File Controller, see <http://www8.hp.com/us/en/products/file-object-storage/product-detail.html>

## Installing the Management Pack software

The HP Storage Management Pack for System Center and its documents are bundled in a `T4282-10518.zip` file.

The `T4282-10518.zip` file, contains the following files:

- `HPStorageManagementPackforSystemCenter.exe`
- `HPStorageManagementPackforSystemCenterUserGuide-4.1.pdf` (User Guide)
- `HP Storage WEBES Listener for System Center.zip`

HP Storage Management Pack for System Center.zip contains the following files:

- HPStorageManagementPackforSystemCenter.exe
- HPStorageMangementPackSilentInstaller.exe
- MPConfig.xml
- MPConfig.xsd

HP Storage WEBES Listener for System Center.zip contains the following files:

- HPStorageWEBESListenerforSystemCenter.exe
- HPStorageWEBESListenerSilentInstaller.exe
- WEBESListenerConfig.xml

## HP Storage Management Pack for System Center

### Installing the HP Storage Management Pack software

Perform the following steps to install the HP Storage Management Pack software on the system that you have designated as an OpsMgr Server:

1. Extract the HPStorageManagementPackforSystemCenter.zip file.
2. Navigate to the extracted folder, and run the HPStorageManagementPackforSystemCenter.exe file.

The Installation wizard starts.

3. Click **Next**.



4. Read the license agreement information and select **I accept the terms in the license agreement**. Click **Next**.





5. Choose one of the following options and click **Next**:

- Install HP Storage Management Pack at C:\Program Files (x86)\HP\ (default).

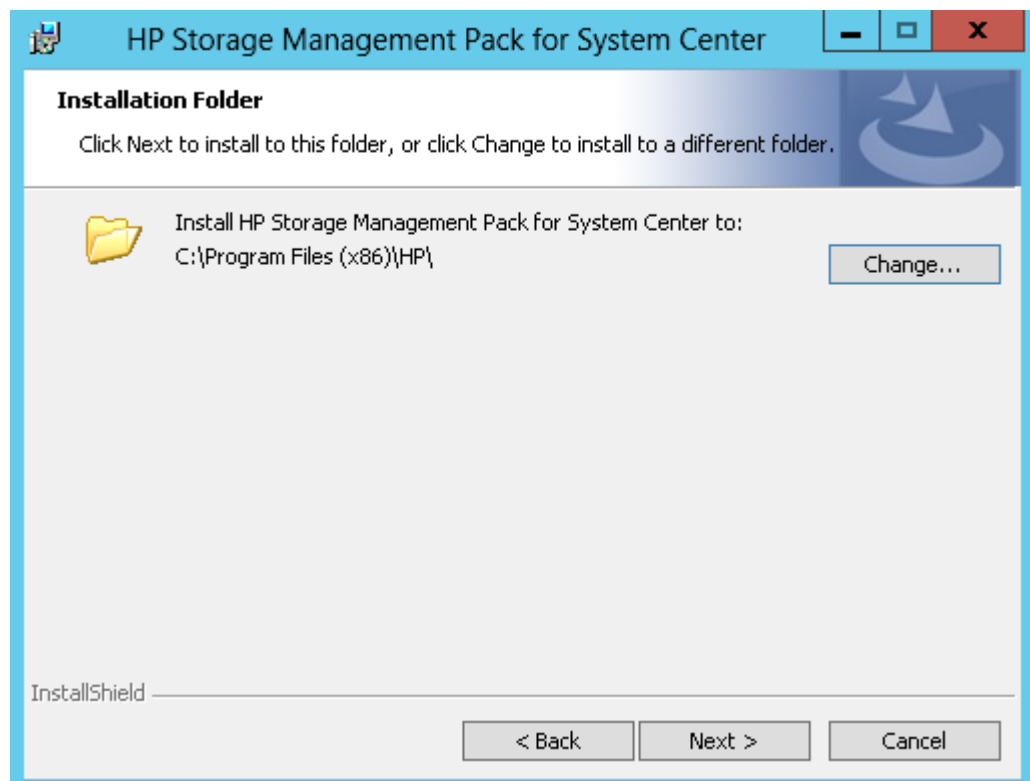

- Click **Change** to install the HP Storage Management Pack to a different location. The folder selection screen is displayed.

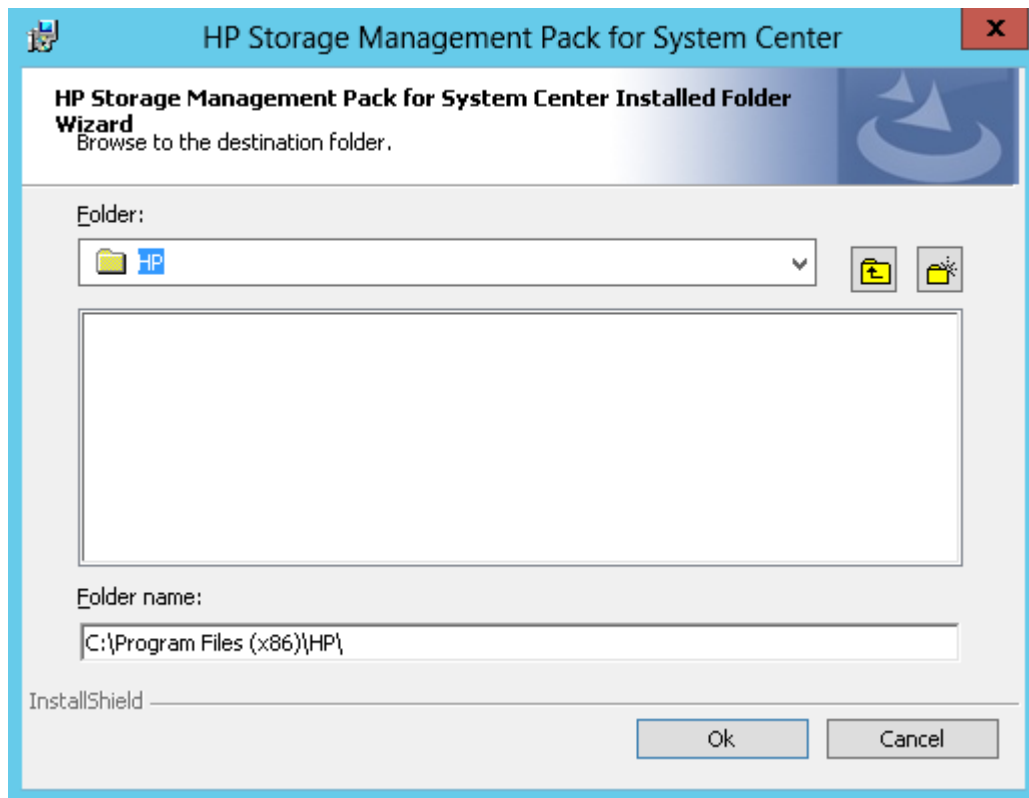

6. Select one of the following options, and click **Next**.

- OpsMgr Server: Server on which the management server is deployed.

---

**NOTE:** HP Storage Management Pack must be installed on the root management server for OpsMgr 2007 R2 RMS environment.

---

- Collection Point Server: Server on which the operations manager agent is deployed, and the SNMP traps or notifications are received.

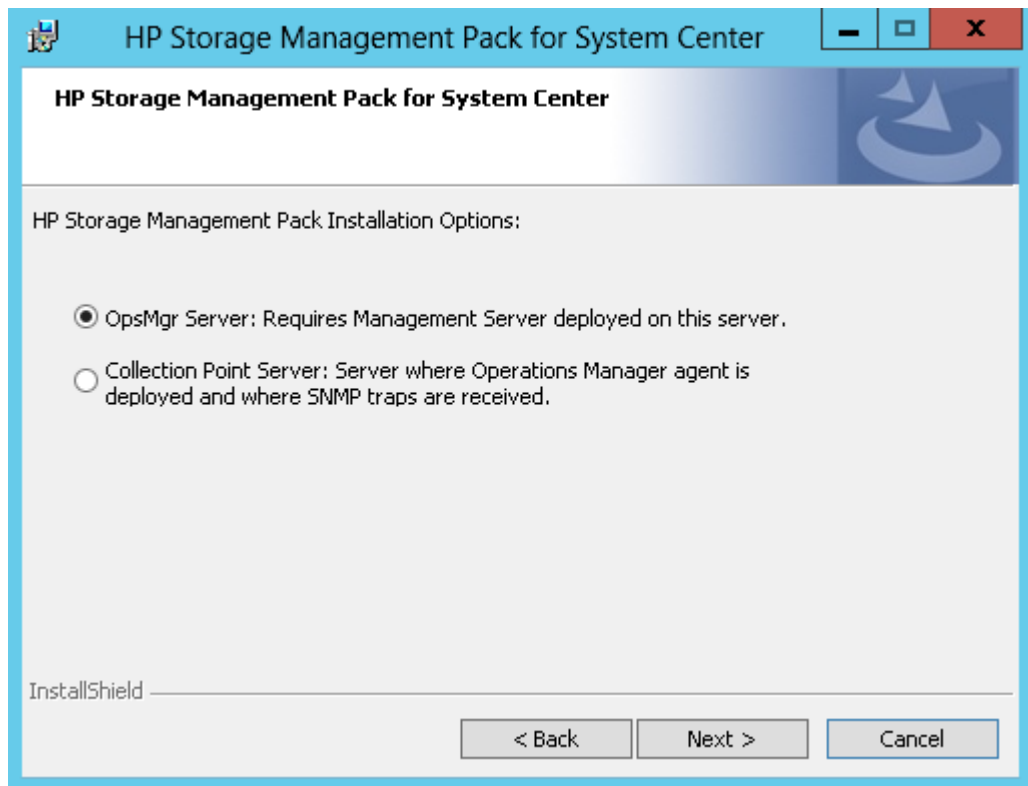

7. Select the check box corresponding to the storage device(s) that you want to monitor, and click **Next**.

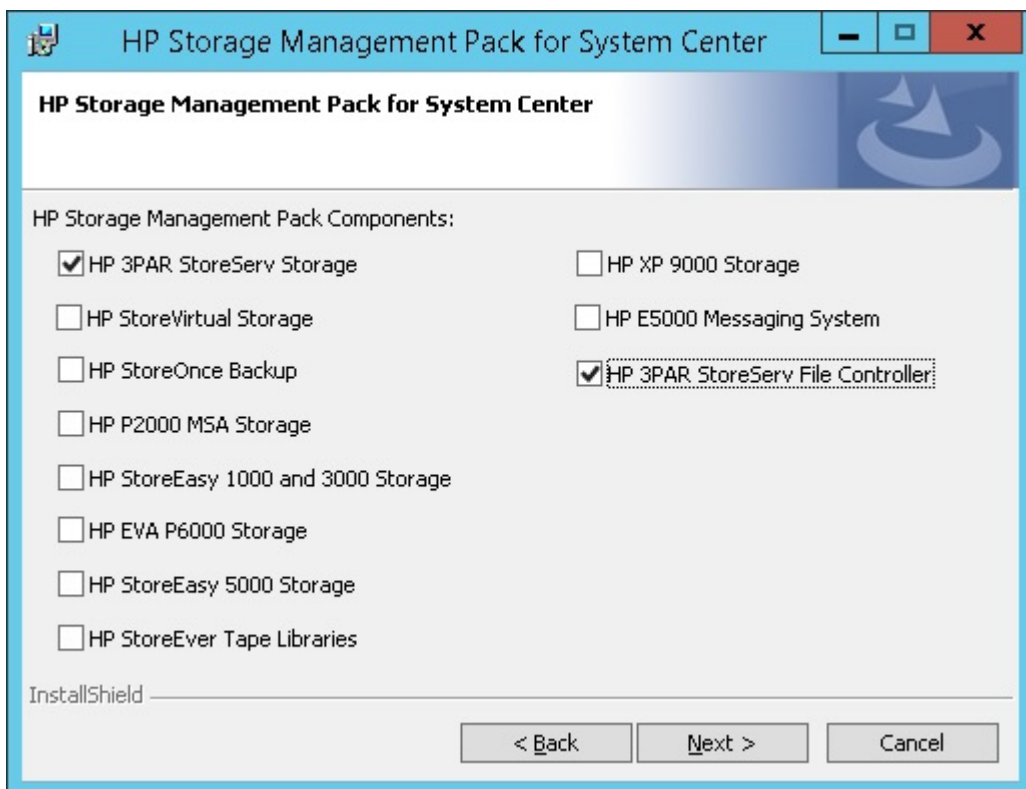

If SCVMM Console is not installed the following pop-up is displayed.

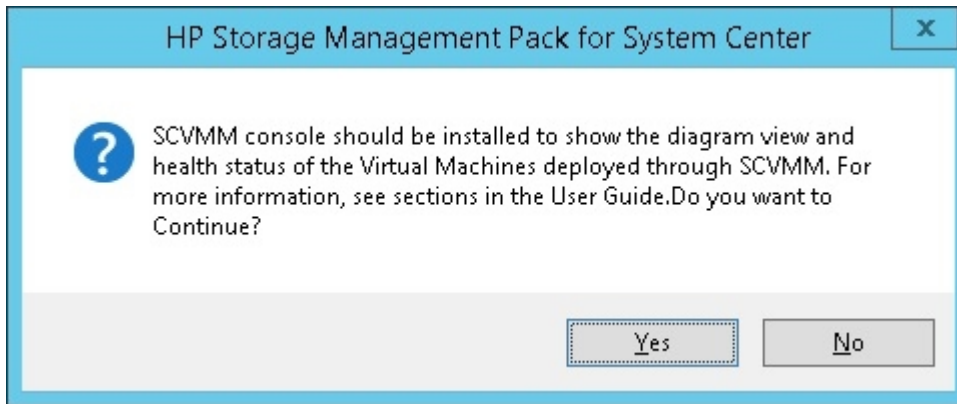

8. Click **Install**

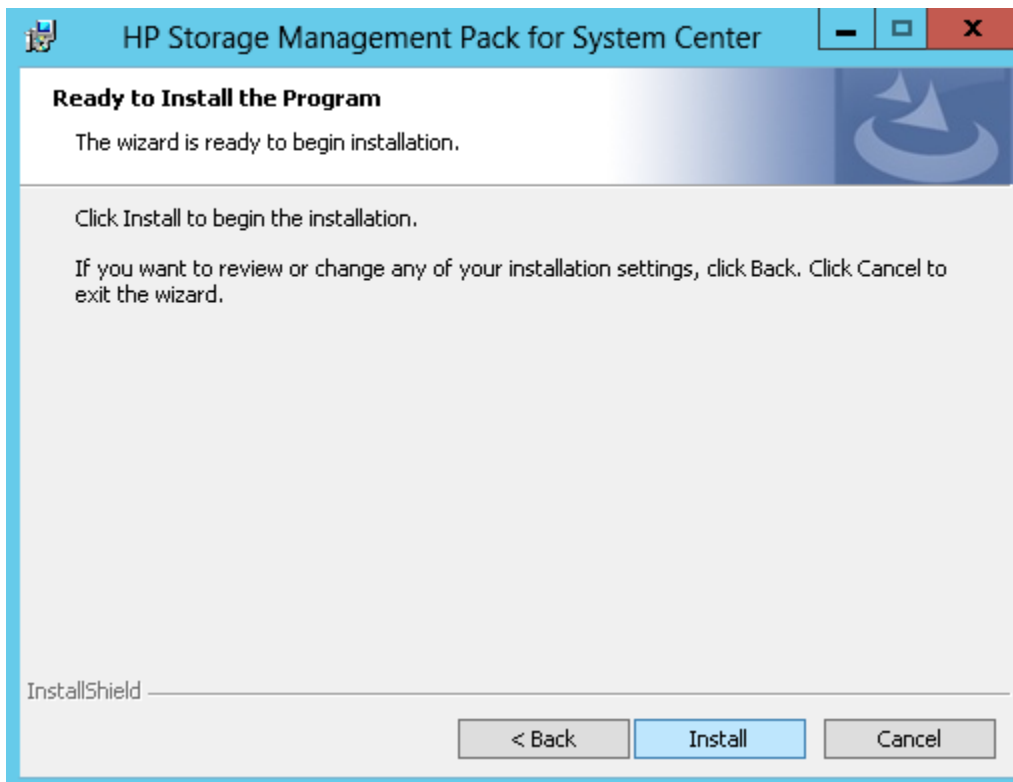

HP Storage Management Pack for System Center installation progress is displayed.

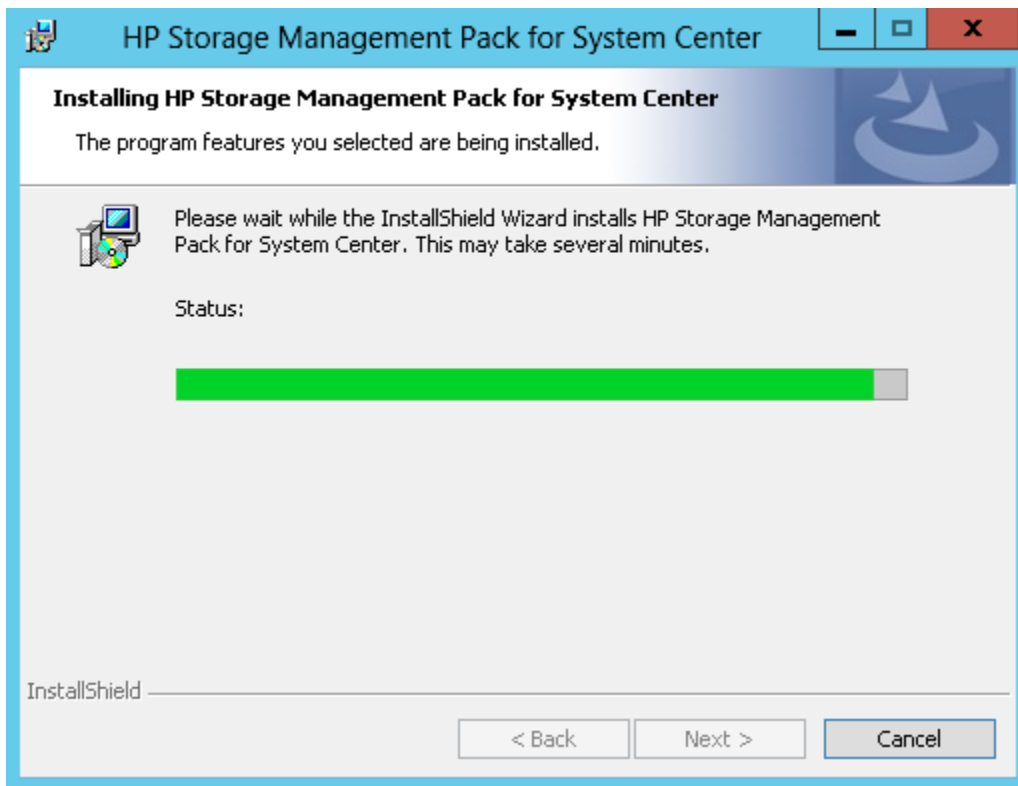

**NOTE:** The installation of HP Storage Management Pack takes some time.

The installation completion screen is displayed.

9. Click **Finish**.



The registry entries for the 32 and 64 bit systems are generated at HKEY\_LOCAL\_MACHINE\SOFTWARE\Hewlett-Packard and HKEY\_LOCAL\_MACHINE\SOFTWARE\Wow6432Node\Hewlett-Packard respectively.

**NOTE:** All installed files are available in ~:\Program Files\HP\HP Storage management Pack for System Center directory for a 32-bit operating system and ~:\Program Files(x86)\HP\HP Storage management Pack for System Center directory for a 64-bit operating system.

## Upgrading HP Storage Management Pack for System Center

Perform the following steps to upgrade the HP Storage Management Pack software:

1. Extract the HPStorageManagementPackforSystemCenter.zip file
2. Navigate to the extracted folder, and run the HPStorageManagementPackforSystemCenter.exe file.
3. Following message will be displayed click **Yes**



The Installation wizard starts.

4. On the **Component Selection** the components installed on OpgMgr are selected for upgrade. You can select other components to install and Click Next.

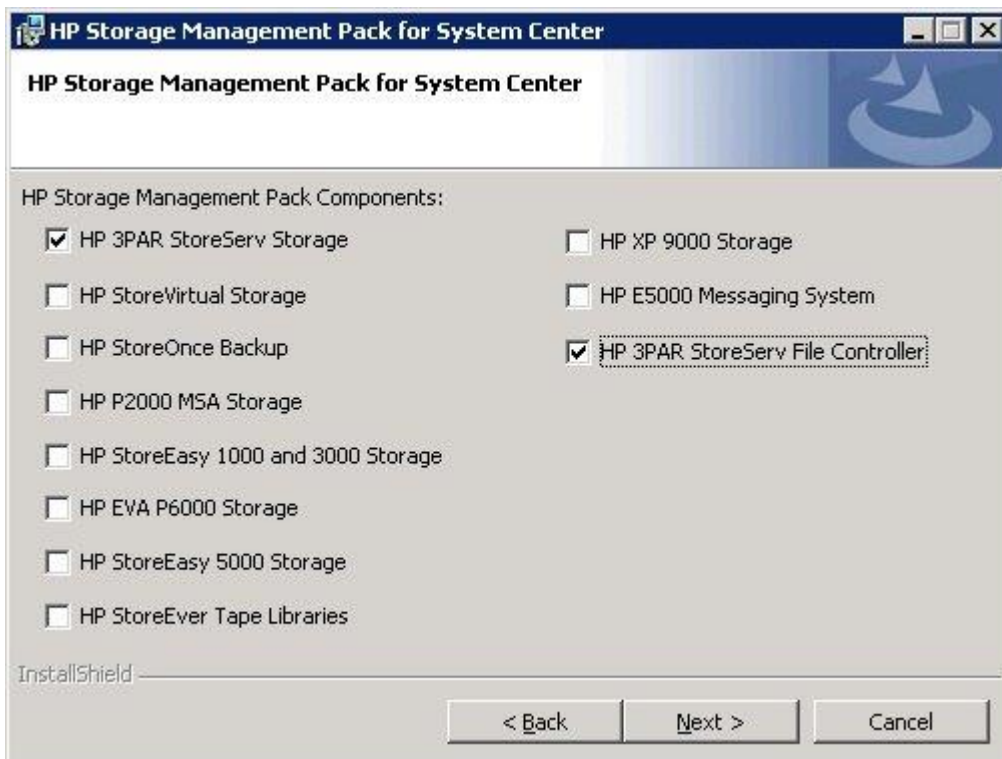

---

**NOTE:**

- Upgrade for HP StoreVirtual is not supported.
  - All components for Collection point are disabled.
- 

5. Select next and complete the upgrade.
- 

**NOTE:** After upgrade, to clear cache, open the **Operations Manager** console with the /clearcache parameter.

For Example:

```
C:\Program Files\System Center Operations Manager  
2012\Console\Microsoft.EnterpriseManagement.Monitoring.Console.exe  
/clearcache
```

---

## Modifying the HP Storage Management Pack software

Perform the following steps to modify the management pack software:

1. Run the HPStorageManagementPackforSystemCenter.exe file and click **Next**.



2. Select **Modify** in the **Program Maintenance** window and click **Next**.

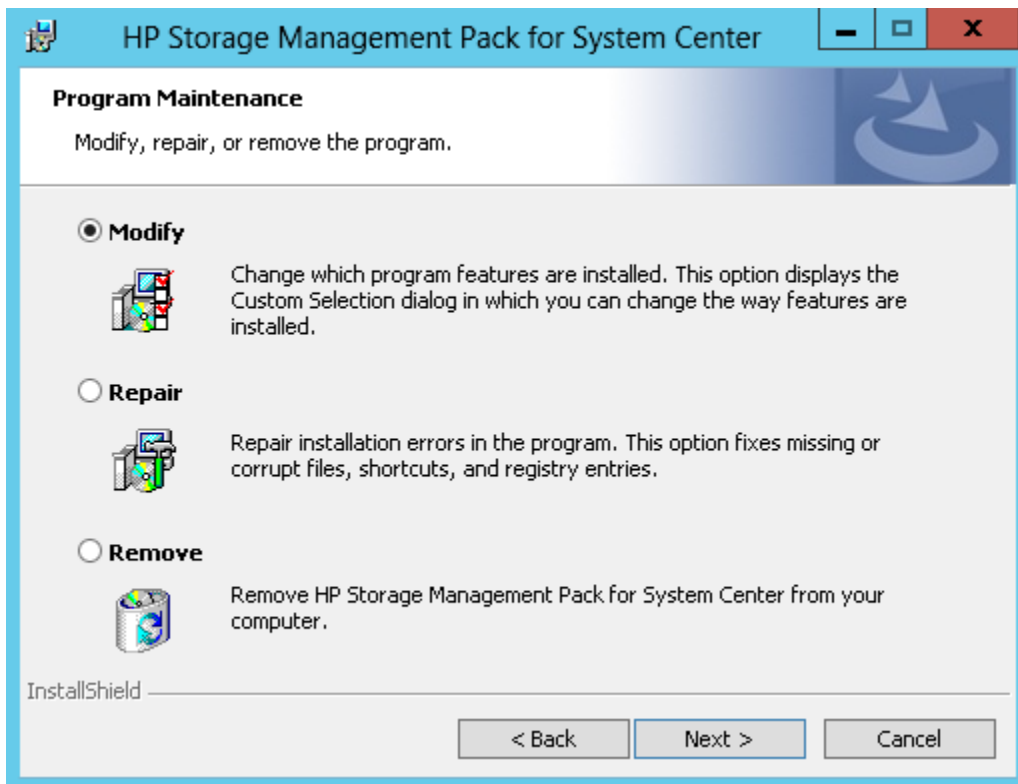

3. Select the check box corresponding to the storage device(s) that you want to monitor, and click **Next**.

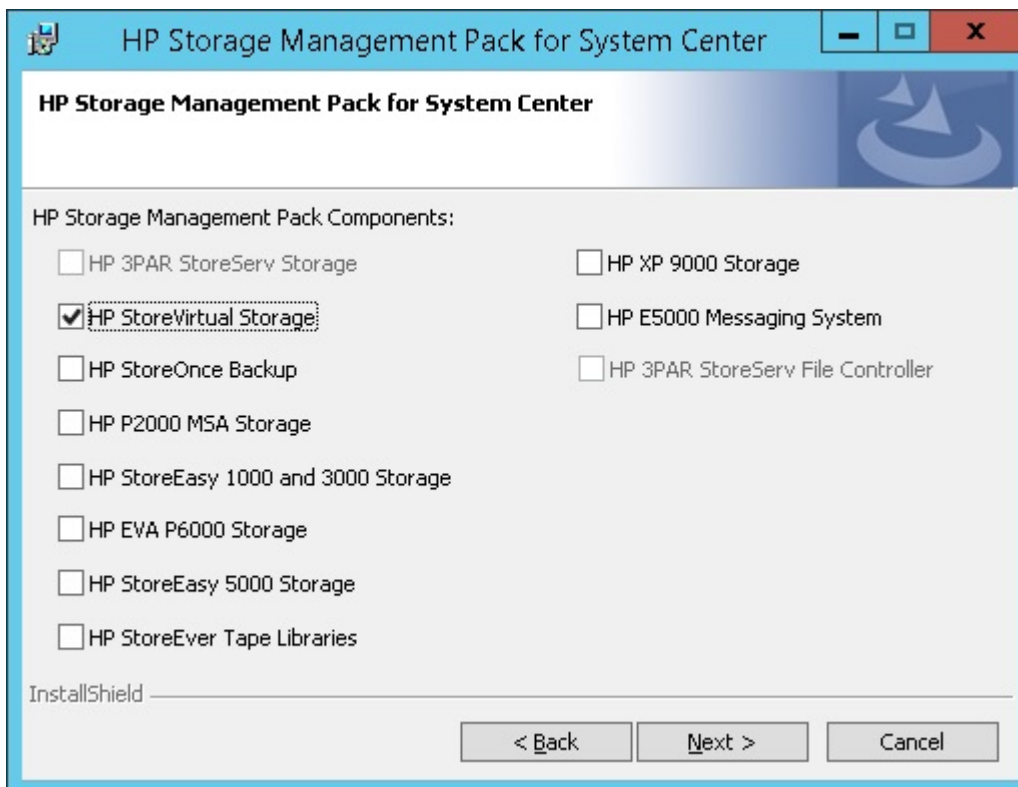

4. Click **Install**.



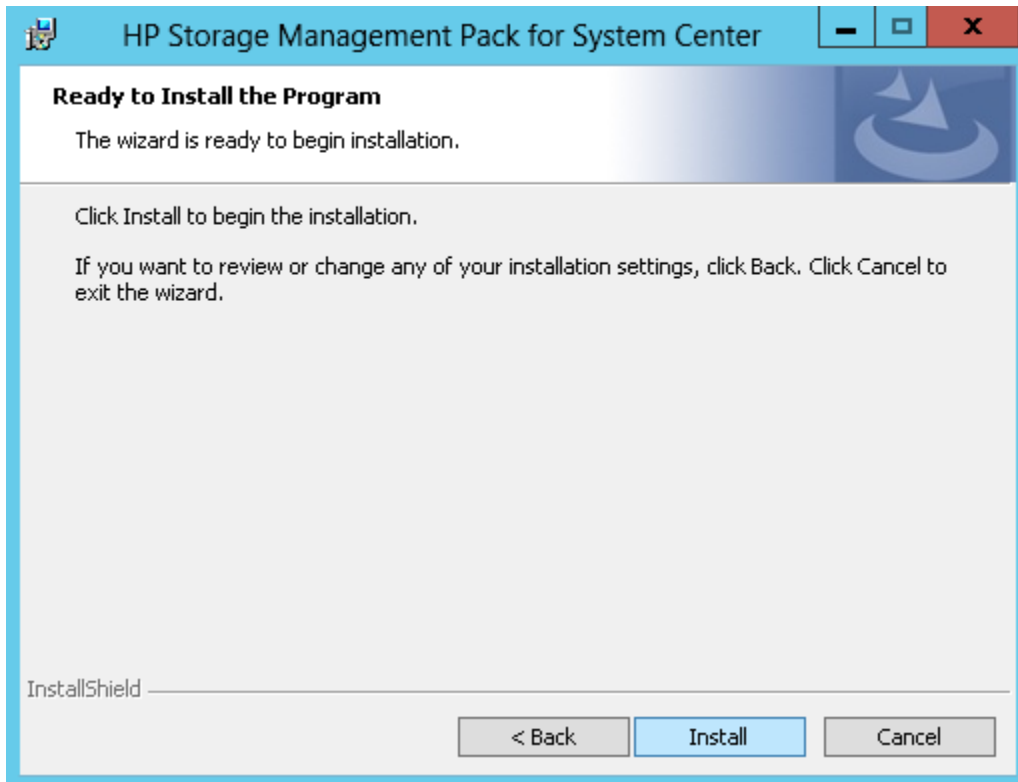

HP Storage Management Pack for System Center installation progress is displayed.

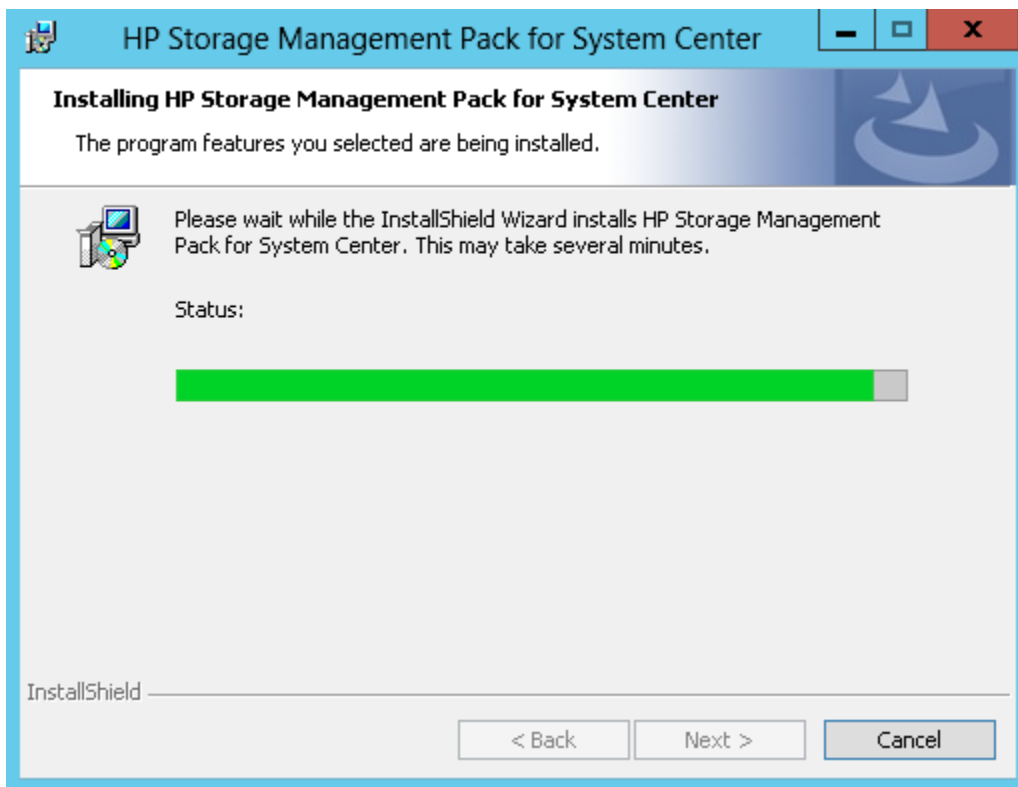

The installation completion screen is displayed.

5. Click **Finish**.



### Repairing the HP Storage Management Pack software

Perform the following steps to repair the management pack software:

1. Run the `HPStorageManagementPackforSystemCenter.exe` file and click **Next**.



2. Select **Repair** in the **Program Maintenance** window and click **Next**.



3. Click **Install**.

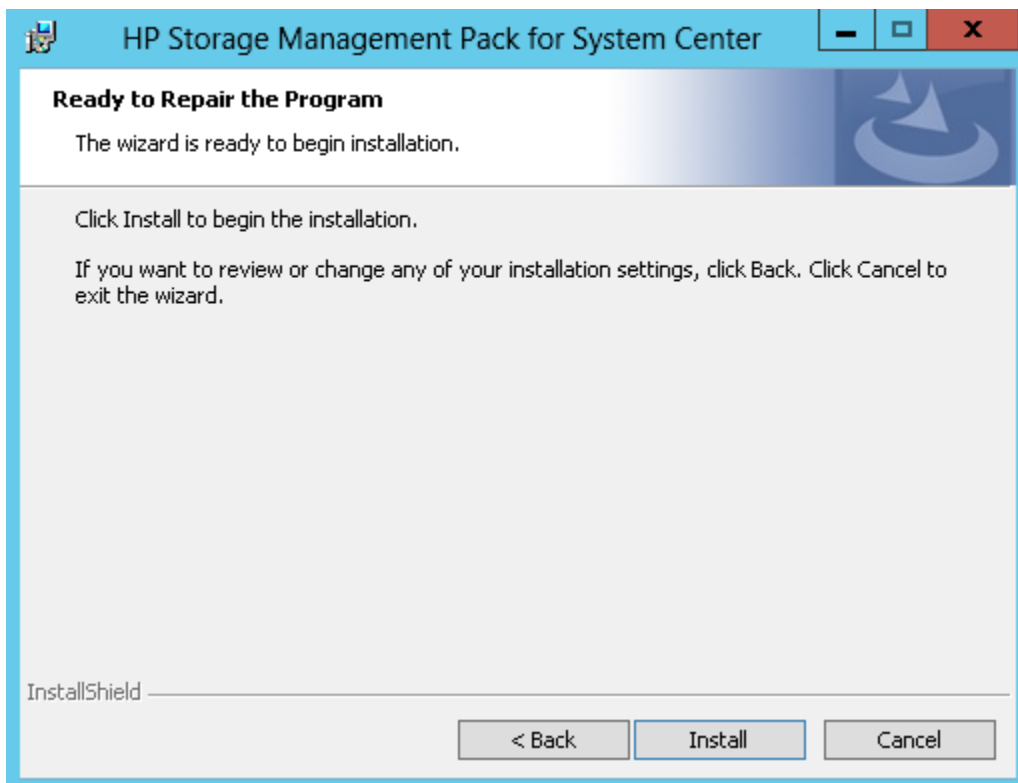

HP Storage Management Pack for System Center installation progress is displayed.

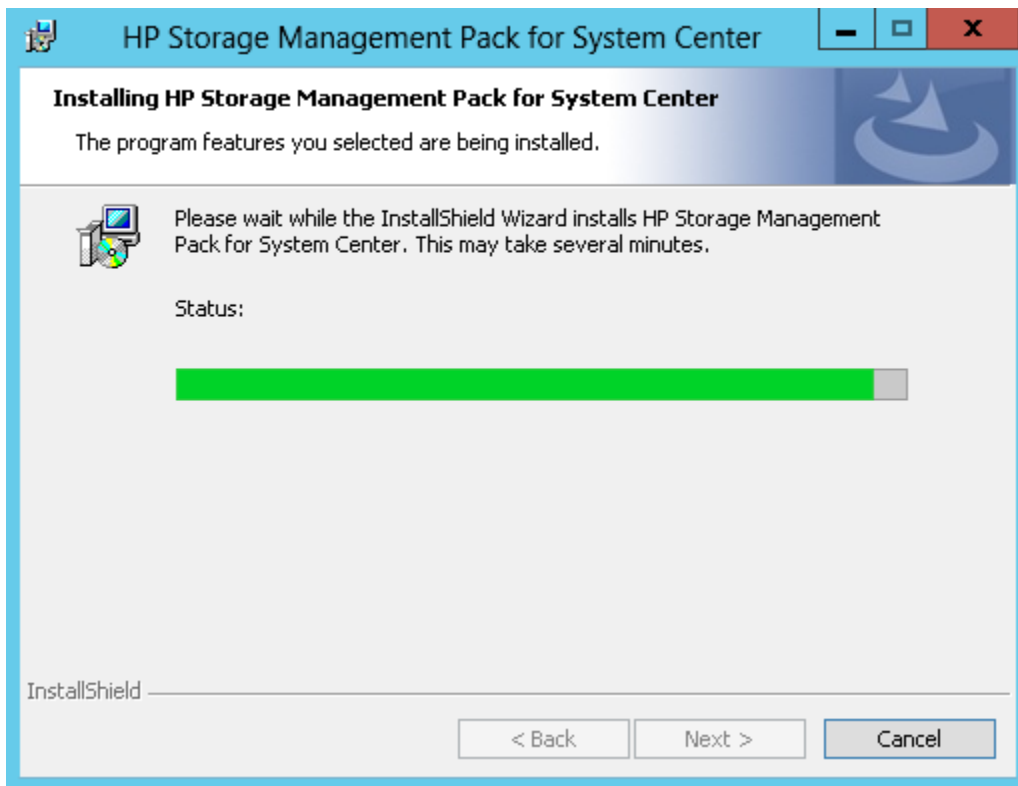

The installation completion screen is displayed.

4. Click **Finish**.



## Uninstalling HP Storage Management Pack for System Center

Before uninstallation, from OpsMgr delete all Management Packs installed and any custom Management Pack installed based on HP Storage Management Packs. Delete in the following order:

- Any custom Management Pack based on any of the HP Storage Management Packs
- Dashboard related Management Packs
- Device Specific HP Storage Management Pack
- HP Storage Libraries Management Pack

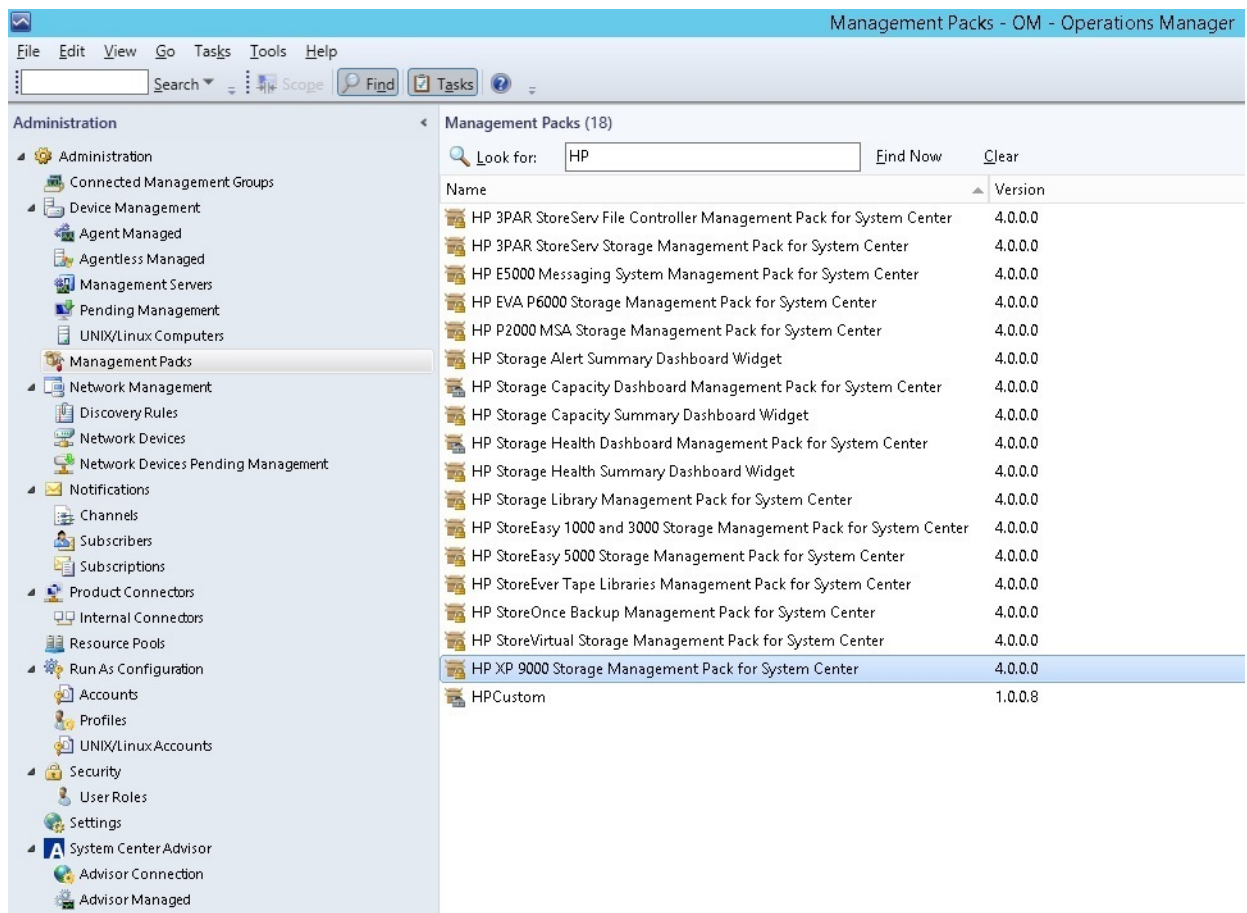

**NOTE:** List of Management Packs displayed in the OpsMgr depends upon the selection of HP Storage Devices done while installation.

Perform the following steps to uninstall the HP Storage Management Pack for System Center for Microsoft Windows Server 2003:

1. Navigate to **Start**→**Settings**→**Control Panel** in Microsoft Windows.
2. Double-click **Add/Remove Programs**.
3. Find **HP Storage Management Pack for System Center**, and click **Remove** to remove the software.

Perform the following steps to uninstall the HP Storage Management Pack for System Center for Microsoft Windows Server 2012 or later:

1. Navigate to **Start**→**Control Panel** in Microsoft Windows.
2. Double-click **Programs and Features**.
3. Find **HP Storage Management Pack for System Center**, and click **Uninstall** to remove the software.

---

**NOTE:** To remove the HP Storage Management Pack for System Center completely from your system, you must manually remove the HP Storage Management Pack for System Center folder from the following location:

- ~:\Program Files\HP\HP Storage Management Pack for System Center for a 32-bit operating system.
  - ~:\Program Files(x86)\HP\HP Storage Management Pack for System Center for a 64-bit operating system.
- 

You can also uninstall the HP Storage Management Pack for System Center by performing the following steps:

1. Run the `HPStorageManagementPackforSystemCenter.exe` file and click **Next**.



2. Select **Remove** in the **Program Maintenance** window and click **Next**.



3. Click **Remove**

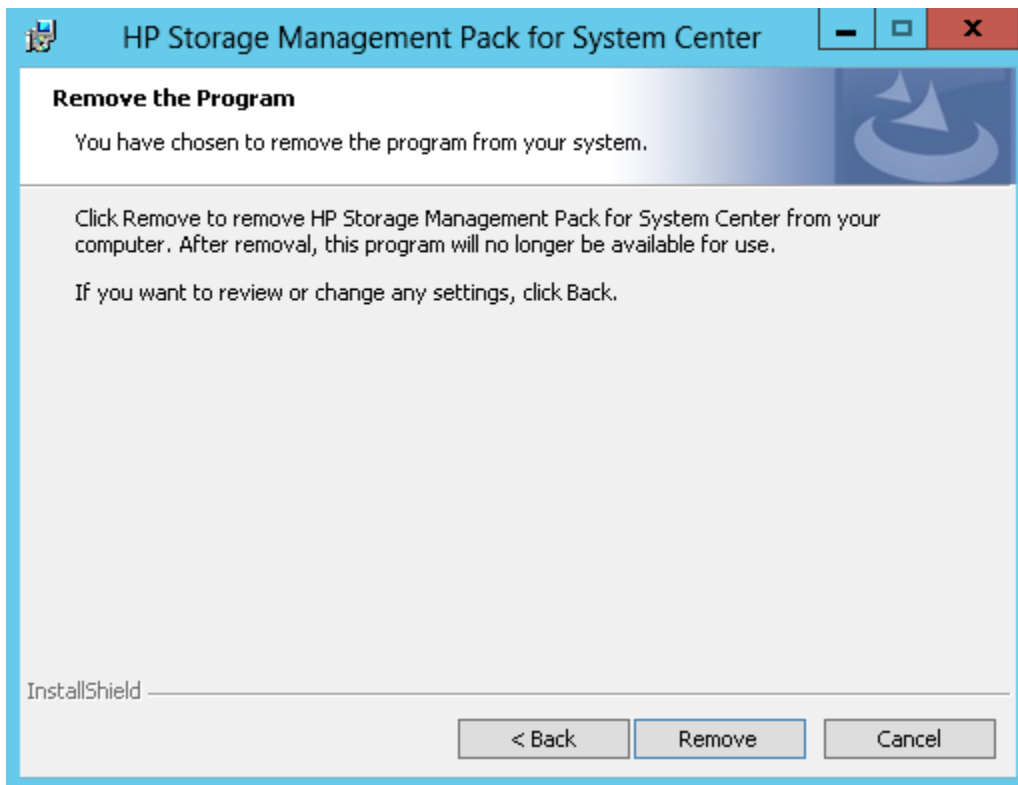

HP Storage Management Pack for System Center uninstallation progress is displayed.

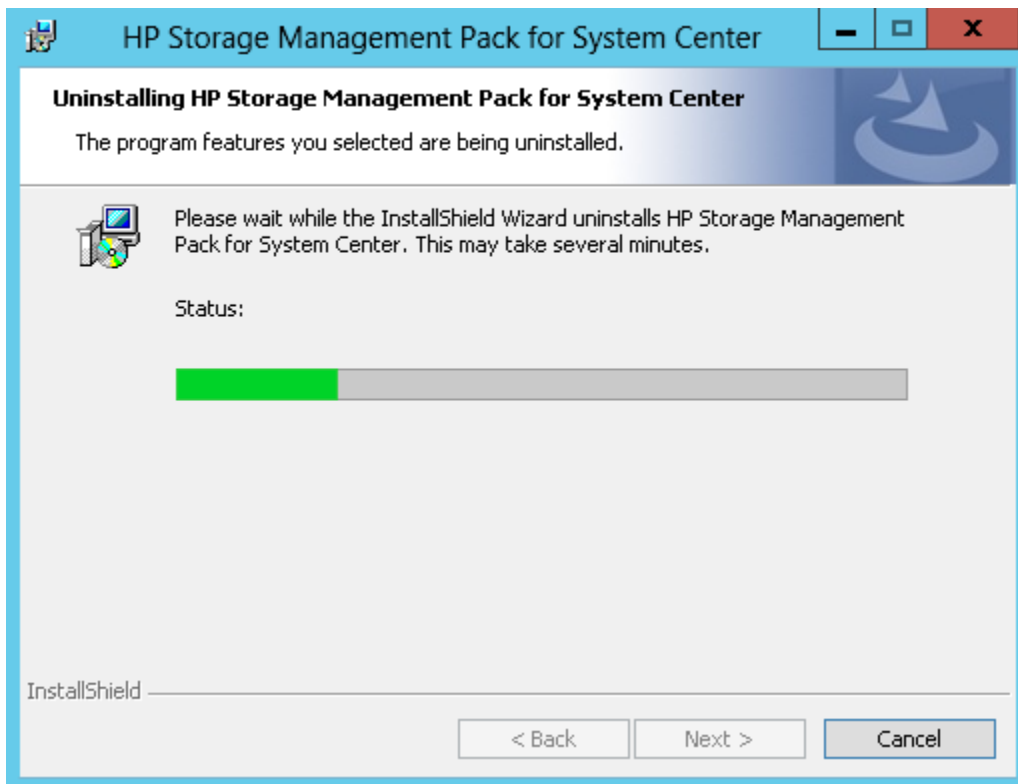

The uninstallation completion screen is displayed.

4. Click **Finish**.



## Silently installing HP Storage Management Pack for System Center

Perform the following steps to silently install the HP Storage Management Pack software:



1. Edit the following fields in the `MPCConfig.xml` file:
  - Enter 1 for the `SilentInstall` tag to perform silent installation. Enter 0 for `SilentUnInstall`, `SilentModify`, and `SilentRepair` tags.
  - Enter 0 for the `InstallDirPath` tag to select the default installation path, that is, `C:\Program Files (x86)\HP\HP Storage Management Pack for System Center`.
  - Enter 1 for the `OpsMgr` and 0 for the `CollectionPoint` tags to install HP Storage Management Pack on the management server.  
Interchange the tag values to install HP Storage Management Pack on the collection point.
  - Enter 1 for the corresponding device tag(s) to import the particular device(s). Enter 0 for the other device tags.  
For example, enter 1 for `ThreePARStoreServ` to import the 3PAR StoreServ device.
2. Save the `MPCConfig.xml` file.
3. In the command prompt, navigate to `HPStorageManagementPackSilentInstaller.exe` and `MPCConfig.xml`.  
Run the `HPStorageManagementPackSilentInstaller.exe`  
The installation is complete after the `SilentMPInstall.log` file is generated.

### Silently modifying HP Storage Management Pack for System Center

Perform the following steps to silently modify the HP Storage Management Pack software:

1. Edit the following fields in the `MPCConfig.xml` file:
  - Enter 1 for the `SilentModify` tag to perform silent modify operation. Enter 0 for `SilentInstall`, `SilentUnInstall`, and `SilentRepair` tags.
  - Do not make any changes to the `InstallDirPath` and `OpsMgr` tags.
  - Enter 1 for the additional device tag(s) to import the particular device(s). Enter 0 for the other device tags.  
For example, enter 1 for `StoreVirtual` and `P2000MSA` to import StoreVirtual and P2000MSA devices in addition to any existing device(s).
2. Save the `MPCConfig.xml` file.
3. In the command prompt, navigate to `HPStorageManagementPackSilentInstaller.exe` and `MPCConfig.xml`.  
Run the `HPStorageManagementPackSilentInstaller.exe`  
The modify operation is complete after the `SilentMPModify.log` file is generated.

### Silently repairing HP Storage Management Pack for System Center

Perform the following steps to silently repair the HP Storage Management Pack software:

1. Edit the following fields in the `MPCConfig.xml` file:
  - Enter 1 for the `SilentRepair` tag to perform silent repair operation. Enter 0 for `SilentInstall`, `SilentUnInstall`, and `SilentModify` tags.
  - Do not make any changes to the `InstallDirPath`, `OpsMgr`, and device tags.
2. Save the `MPCConfig.xml` file.
3. In the command prompt, navigate to `HPStorageManagementPackSilentInstaller.exe` and `MPCConfig.xml`.  
Run the `HPStorageManagementPackSilentInstaller.exe`  
The repair operation is complete after the `SilentMPRepair.log` file is generated.

## Silently uninstalling HP Storage Management Pack for System Center

Perform the following steps to silently uninstall the HP Storage Management Pack software:

1. Edit the following fields in the `MPCConfig.xml` file:
  - Enter 1 for the `SilentUnInstall` tag to perform silent uninstallation. Enter 0 for `SilentInstall`, `SilentRepair`, and `SilentModify` tags.
  - Do not make any changes to the `InstallDirPath`, `OpsMgr`, and device tags.
2. Save the `MPCConfig.xml` file.
3. In the command prompt, navigate to `HPStorageManagementPackSilentInstaller.exe` and `MPCConfig.xml`.

Run the `HPStorageManagementPackSilentInstaller.exe`

The uninstallation is complete after the `SilentMPUninstall.log` file is generated.

## HP Storage WEBES Listener for System Center

### WMI Listener in OpsMgr

The OpsMgr provides an in built capability to listen to the WMI events. It is used as a data source module type and helps to:

- Issue an event-related query to a WMI namespace at a polling interval.
- Define an event-related WMI query that will subscribe to a particular event-publishing WMI class.
- Receive notifications at the specified interval as WMI events occur.

---

**NOTE:** HP Storage WEBES Listener for System Center requires .Net framework 3.0, 3.5, 4.1, and 4.5. Hence ensure that .Net framework 3.5 is installed on the server.

---

### Installing WEBES Listener on WEBES collection point systems

Figure 5 (page 35) shows the WEBES collection point system.

Figure 5 WEBES event flow to collection points

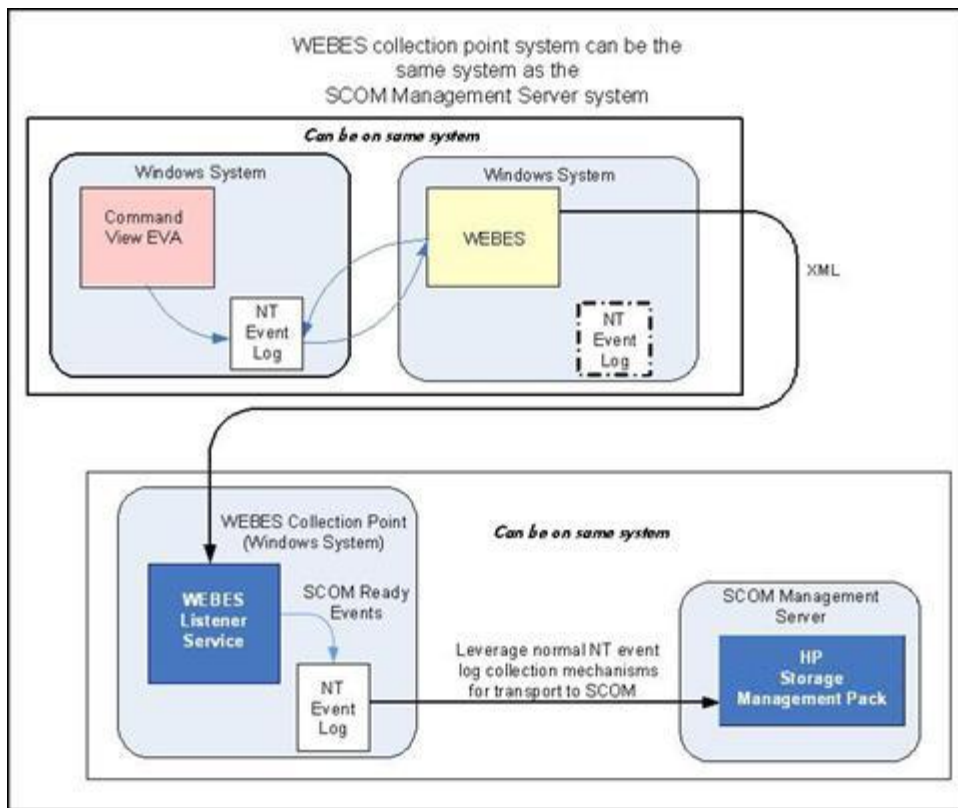

**NOTE:** Ensure that the previous version of the HP Storage WEBES Listener for System Center is uninstalled before installing the newer version.

Perform the following steps on each system that you plan to use as a WEBES collection point:

1. Ensure that the HP Storage WEBES Listener for System Center.zip file is available to the systems that have to be configured as WEBES collection points.
2. Extract the HP Storage WEBES Listener for System Center.zip file.
3. Navigate to the extracted folder, and run the HPStorageWEBESListenerforSystemCenter.exe file.

The Installation wizard starts.



4. Read the license agreement information and select **I accept the terms in the license agreement**. Click **Next**.



5. Perform one of the following and click **Next**:
  - Install HP Storage WEBES Listener for System Center at C:\Program Files (x86)\HP\HP Storage WEBES Listener for System Center\ (default).

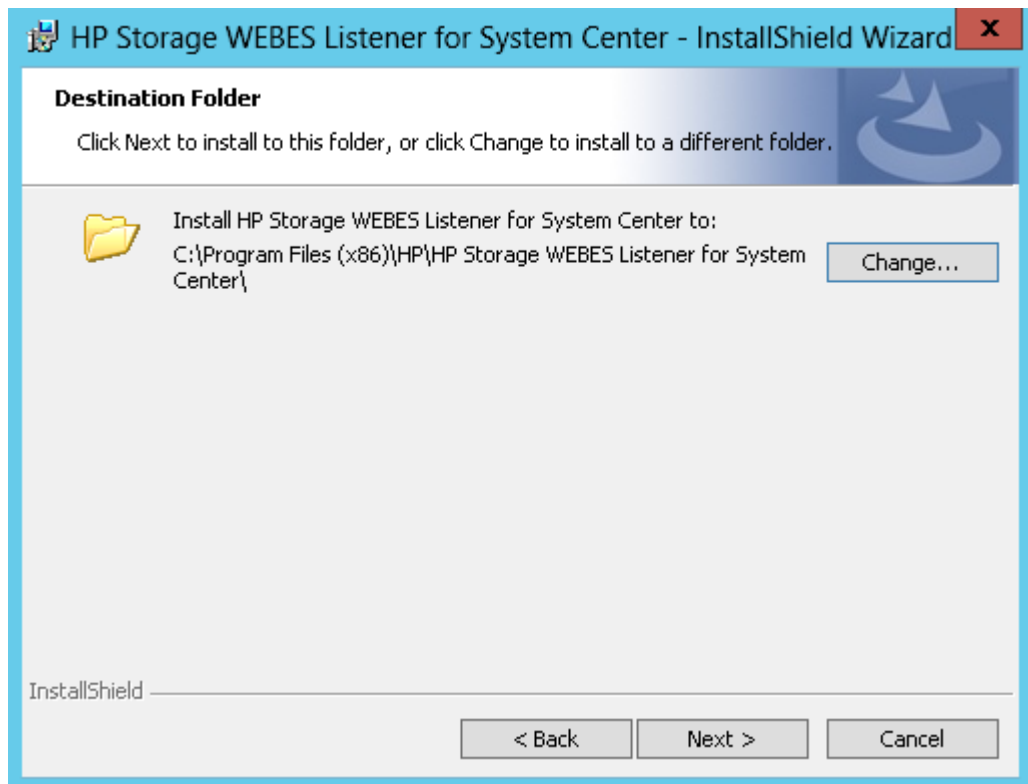

- Click **Change** to install the HP Storage WEBES Listener for System Center to a different location. The folder selection screen is displayed.

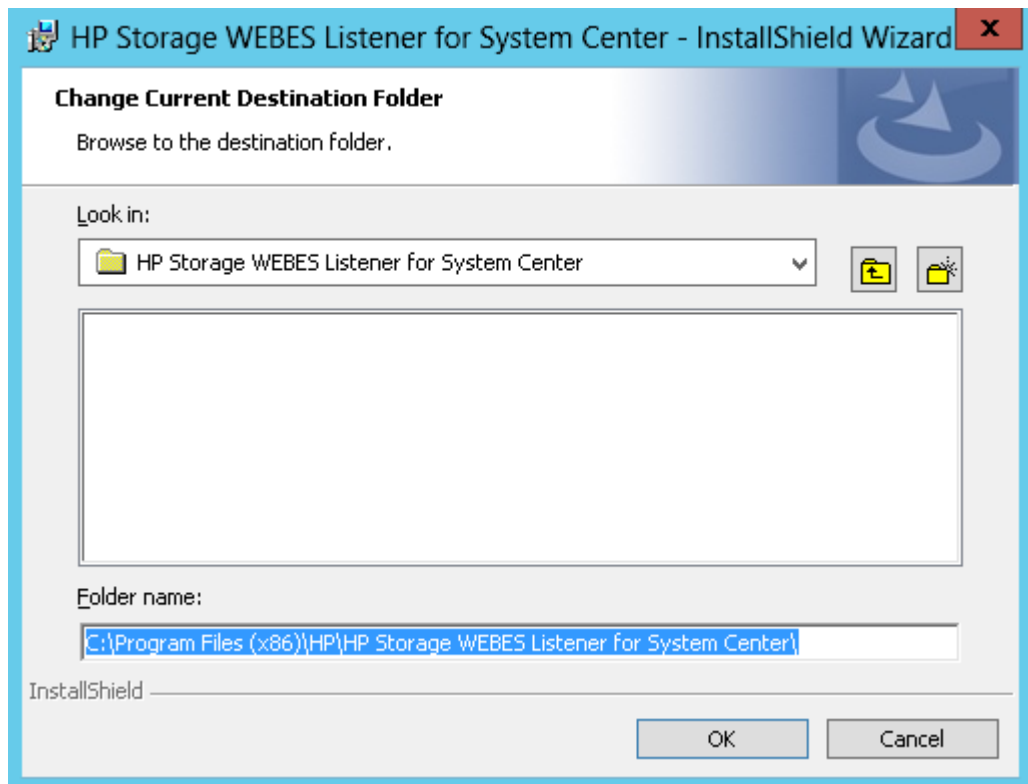

6. Click **Install**.

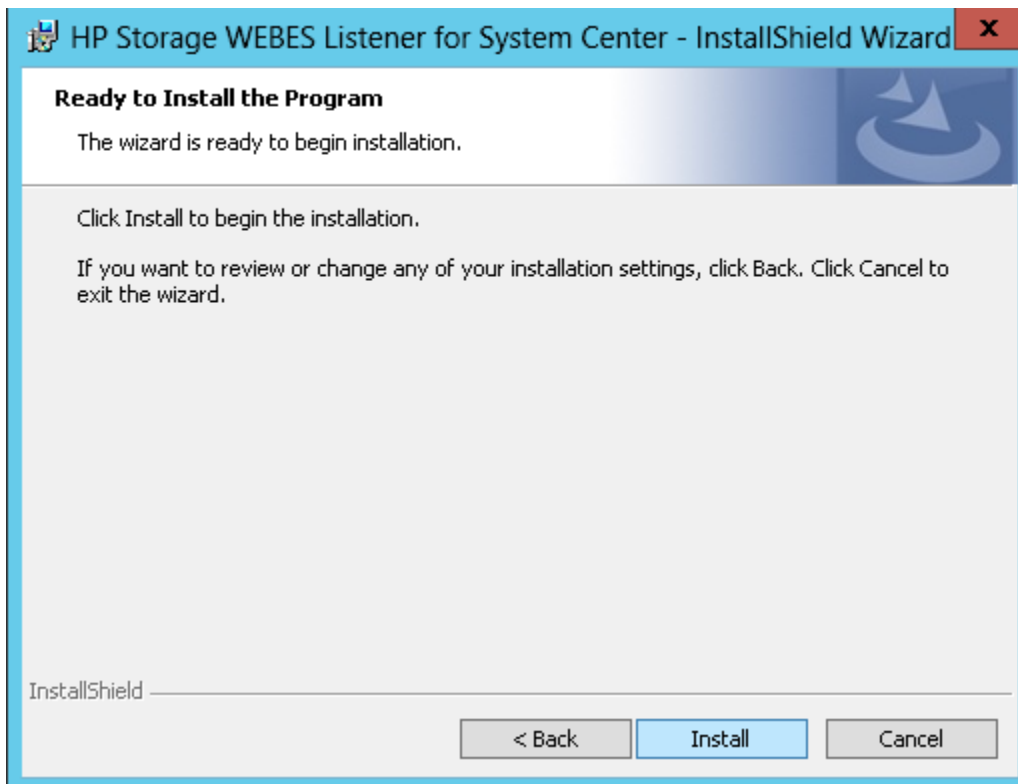

HP Storage WEBES Listener for System Center installation takes some time. The installation completion screen is displayed.

7. Click **Finish**.



The registry entries for the 32 and 64 bit systems are generated at `HKEY_LOCAL_MACHINE\SOFTWARE\Hewlett-Packard` and `HKEY_LOCAL_MACHINE\SOFTWARE\Wow6432Node\Hewlett-Packard` respectively.

## Repairing the HP Storage WEBES Listener for System Center

Perform the following steps to repair the HP Storage WEBES Listener for System Center:

1. Run the `HPStorageWEBESListenerforSystemCenter.exe` file and click **Next**.



2. Select **Repair** in the **Program Maintenance** window and click **Next**.



3. Click **Install**.

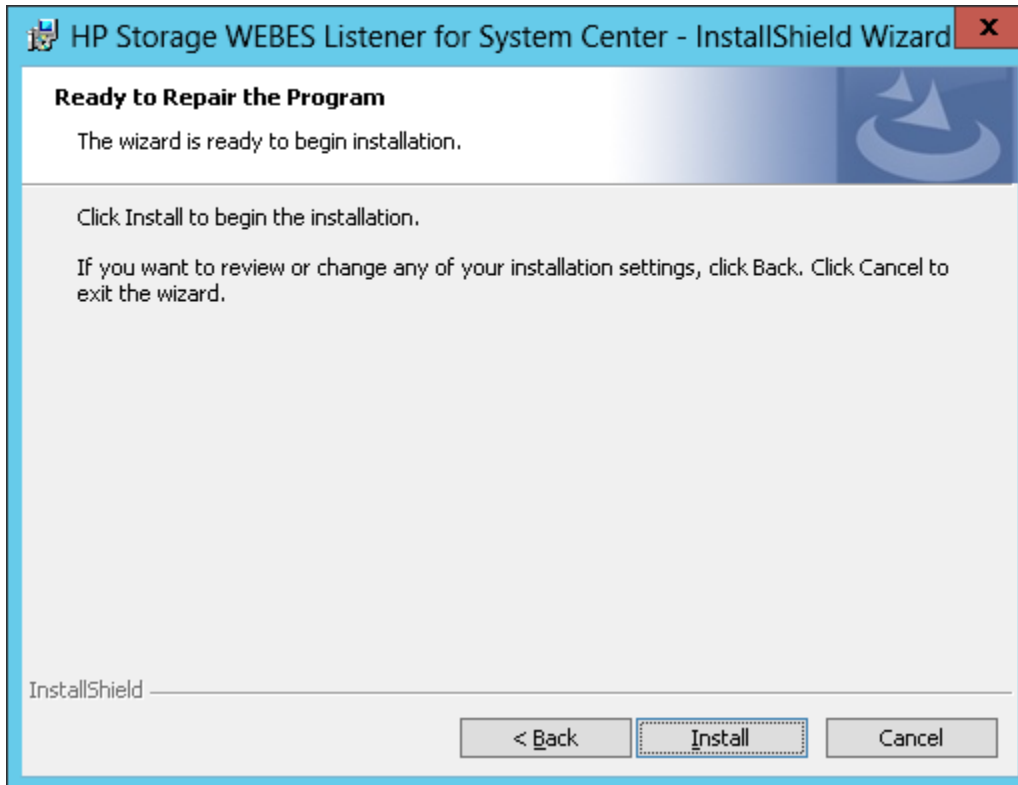

The installation completion screen is displayed.

4. Click **Finish**.





## Uninstalling HP Storage WEBES Listener for System Center

Perform the following steps to uninstall the HP Storage WEBES Listener for System Center for Microsoft Windows Server 2003:

1. Navigate to **Start**→**Settings**→**Control Panel** in Microsoft Windows.
2. Double-click **Add/Remove Programs**.
3. Find **HP Storage WEBES Listener for System Center**, and click **Remove** to remove the software.

Perform the following steps to uninstall the HP Storage WEBES Listener for System Center for Microsoft Windows Server 2012 or later:

1. Navigate to **Start**→**Control Panel** in Microsoft Windows.
2. Double-click on **Programs and Features**.
3. Find **HP Storage WEBES Listener for System Center**, and click **Uninstall** to remove the software.

---

**NOTE:** To remove the HP Storage WEBES Listener for System Center completely from your system, you must manually remove the following files:

- For a 32-bit operating system:
  - `~:\Program Files\HP\HP Storage WEBES Listener for System Center\WEBESListenerLog.log`
  - `~:\Program Files\HP\HP Storage WEBES Listener for System Center\InstallLog.log`
  - `~:\Program Files\HP\HP Storage WEBES Listener for System Center\UninstallLog.log`
- For a 64-bit operating system:
  - `~:\Program Files(x86)\HP\HP Storage WEBES Listener for System Center\WEBESListenerLog.log`
  - `~:\Program Files(x86)\HP\HP Storage WEBES Listener for System Center\InstallLog.log`
  - `~:\Program Files(x86)\HP\HP Storage WEBES Listener for System Center\UninstallLog.log`

---

You can also uninstall the HP Storage WEBES Listener for System Center by performing the following steps:

1. Run the `HPStorageWEBESListenerforSystemCenter.exe` file and click **Next**.



2. Select **Remove** in the **Program Maintenance** window and click **Next**.

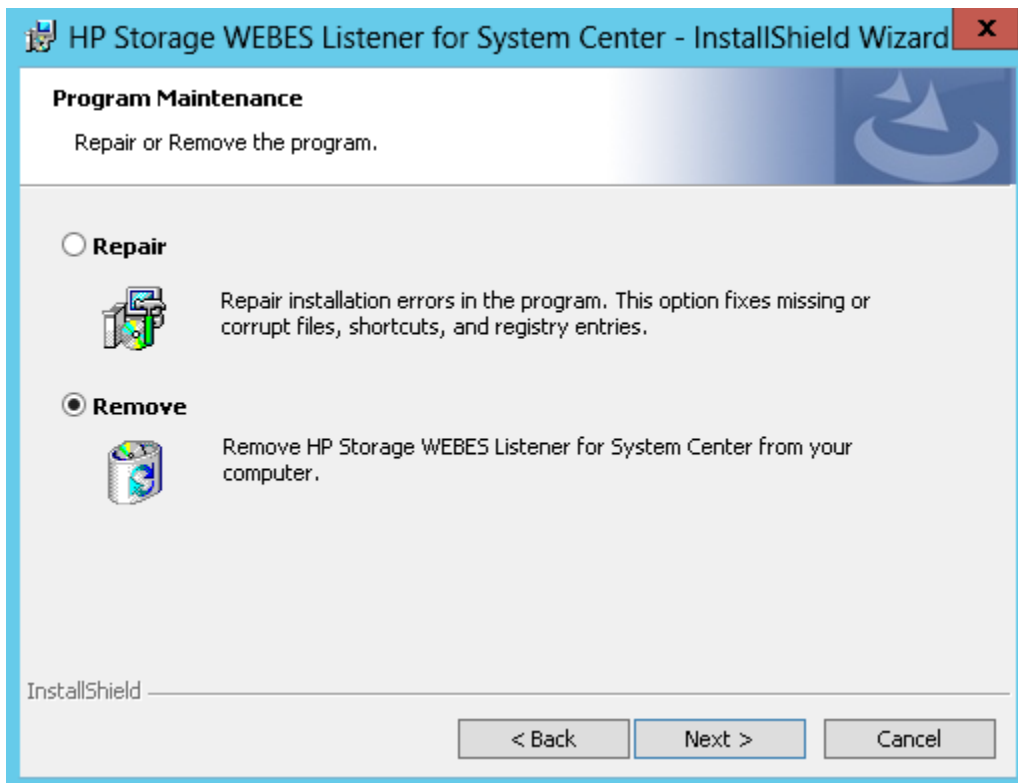

3. Click **Remove**

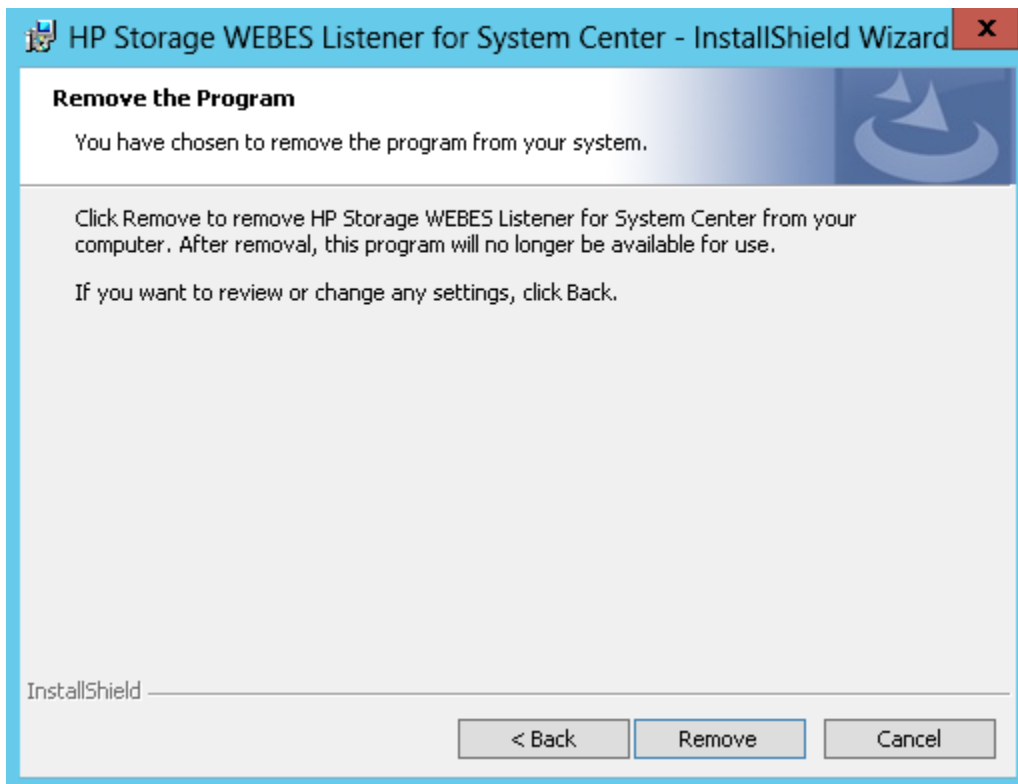

The installation completion screen is displayed.

4. Click **Finish**.



## Silently installing HP Storage WEBES Listener for System Center

Perform the following steps to silently install the HP Storage WEBES Listener for System Center:

1. Edit the `WEBESListenerConfig.xml` file.  
Enter 1 for the `SilentInstall` tag to perform silent installation. Enter 0 for `SilentUnInstall` and `SilentRepair` tags.
2. Save the `WEBESListenerConfig` file.
3. Run the `HPStorageWEBESListenerSilentInstaller.exe`  
The installation is complete after the `SilentWEBESInstall.log` file is generated.

## Silently repairing HP Storage WEBES Listener for System Center

Perform the following steps to silently repair the HP Storage WEBES Listener for System Center:

1. Edit the `WEBESListenerConfig.xml` file.  
Enter 1 for the `SilentRepair` tag to perform silent repair operation. Enter 0 for `SilentInstall` and `SilentUnInstall` tags.
2. Save the `WEBESListenerConfig` file.
3. Run the `HPStorageWEBESListenerSilentInstaller.exe`  
The repair operation is complete after the `SilentWEBESRepair.log` file is generated.

## Silently uninstalling HP Storage WEBES Listener for System Center

Perform the following steps to silently uninstall the HP Storage WEBES Listener for System Center:

1. Edit the `WEBESListenerConfig.xml` file.  
Enter 1 for the `SilentUnInstall` tag to perform silent installation. Enter 0 for `SilentInstall` and `SilentRepair` tags.
2. Save the `WEBESListenerConfig` file.
3. Run the `HPStorageWEBESListenerSilentInstaller.exe`  
The uninstallation is complete after the `SilentWEBESUninstall.log` file is generated.

## Discovery of HP Storage devices using HP Storage Management Pack User Configuration Tool

To monitor HP Storage devices in the OpsMgr Diagram View, ensure that the Storage device is discovered in the HP Storage Management Pack user configuration tool.

## Discovering HP Storage devices in the HP Storage Management Pack User Configuration Tool

1. Launch `HP Storage Management Pack User Configuration Tool.exe` from the HP Storage Management Pack for System Center folder created in the start menu. The tool is also present in the install directory path of HP Storage Management Pack for System Center.
2. Enter OpsMgr host name or the IP address and click **Connect**.

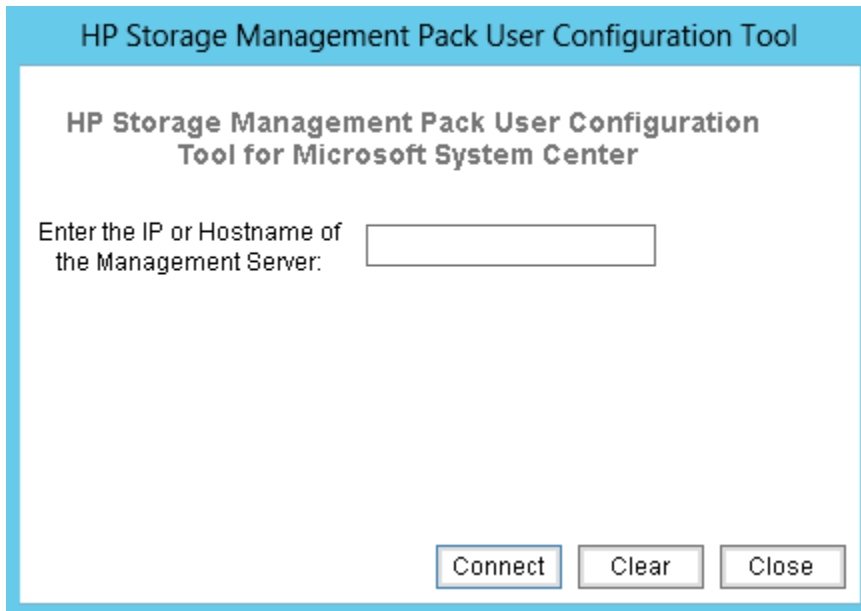

**NOTE:** If present server is OpsMgr gateway server or server in other domain, enter OpsMgr domain credentials or the server credentials to click the **Connect** button.

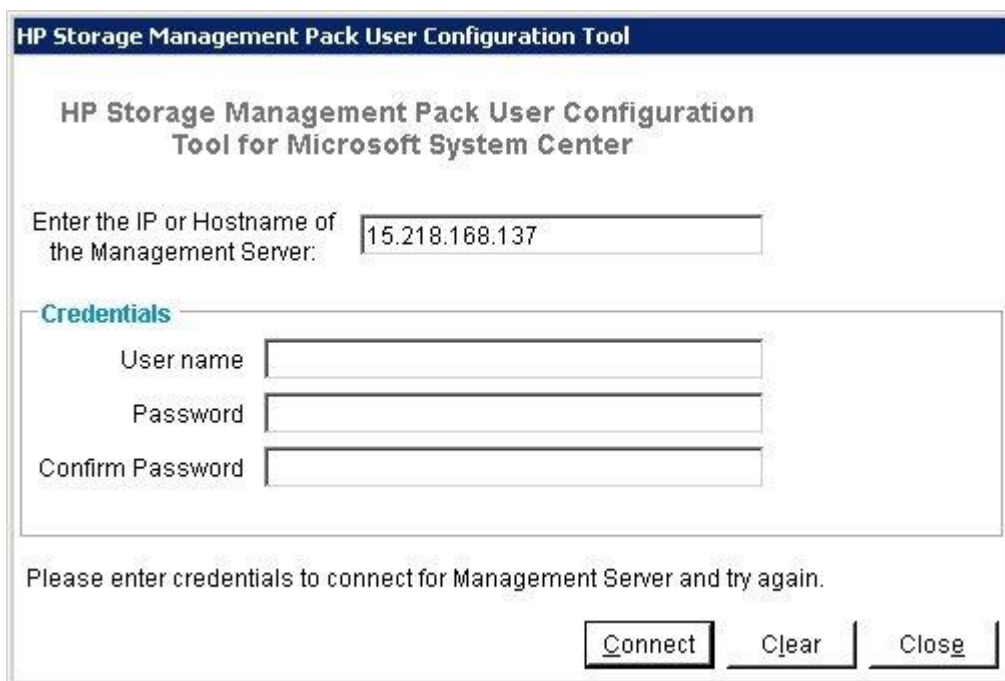

The HP Storage Management Pack User Configuration Tool main screen is displayed.

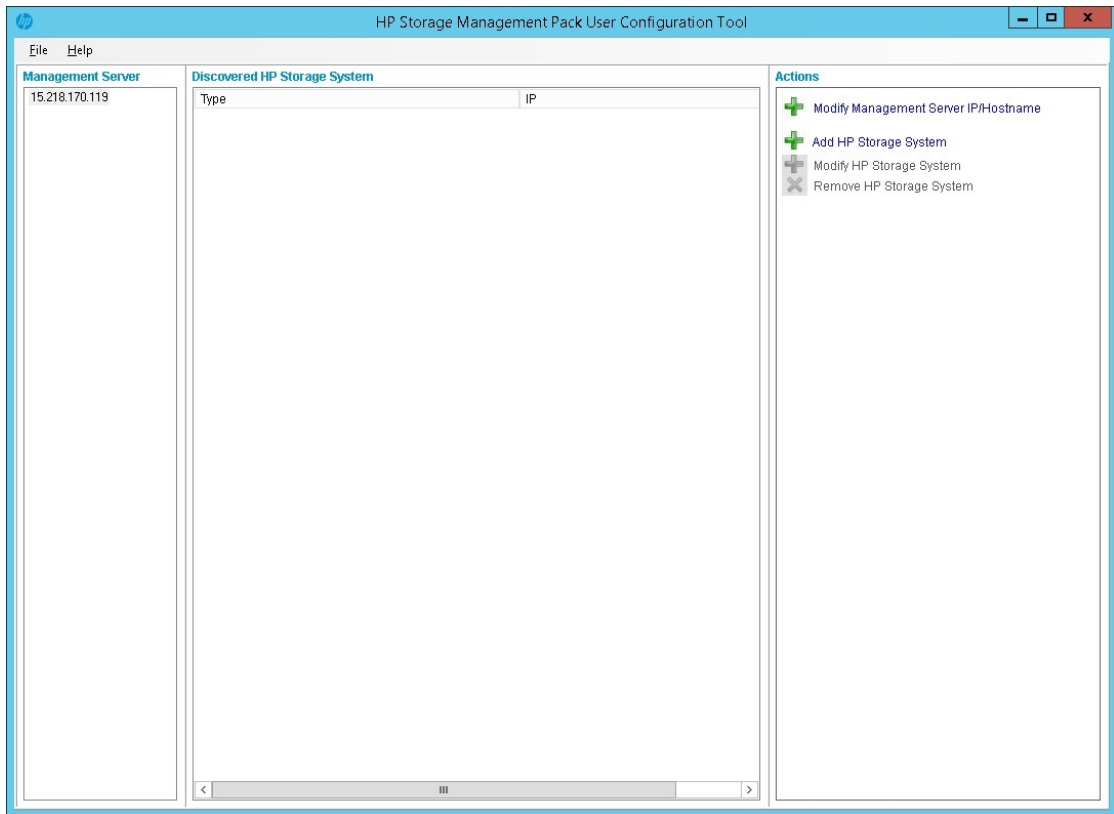

3. Click **Add HP Storage System** in the actions panel of the dashboard to add the HP Storage devices.  
Select the type of device from the drop down list, enter IP address and credential details and click **Add**.

### Add HP Storage System

**Details**

Select the Type of Device HP 3PAR StoreServ Storage

Enter the IP address 1.1.1.1

**Credentials**

User name scom

Password \*\*\*\*\*

Confirm Password \*\*\*\*\*

**Configure SCVMM Server**

To monitor diagram view and health status of the Virtual Machines deployed through SCVMM, enter the IP or Hostname of the SCVMM server for HP 3PAR StoreServ storage.

**SCVMM Server**

Enter the IP or Hostname

Add
Clear
Close

**NOTE:** If a virtual machine managed in System Center Virtual Machine Manager is created using HP 3PAR StoreServ Storage, then the IP can be configured optionally. This functionality is supported for HP 3PAR StoreServ Storage.

If Collection point server is gateway server or server in other domain as OpsMgr you need to enter the domain credentials System Center Virtual Machine Manager to connect.

It is recommended to use the superuser account while discovering HP 3PAR StoreServ Storage, to view all the CPGs, Virtual Volumes and Virtual Machines in the diagram view.

Credentials are not required to discover the HP StoreVirtual Storage, HP StoreEasy 5000 Storage, HP E5000 Messaging System, HP 3PAR StoreServ File Controller. However the SMI-S credentials are required for the HP 3PAR StoreServ Storage and HP P2000 MSA Storage.

To discover a HP 3PAR StoreServ Storage Successfully , ensure Port 8080 is opened on both OpsMgr as well as Collection Point Server.

A Community String is required to identify the SNMP traps for discovering HP StoreVirtual Storage.

### Add HP Storage System

**Details**

Select the Type of Device

Enter the IP address

**SNMP Settings**

Community String

4. After a storage device is successfully discovered, it will be displayed in the Discovered HP Storage System panel.

## Modifying credentials of HP Storage devices in HP Storage Management Pack user configuration tool

1. Select the storage device that needs to be modified and click **Modify HP Storage System** in the Actions panel.



2. Enter the credentials of the storage device provider and click **Modify**.

### Modify HP Storage System Data

**Details**

Select the Type of Device

Enter the IP address

**Credentials**

User name

Password

Confirm Password

**Modify SCVMM Server**

To monitor diagram view and health status of the Virtual Machines deployed through SCVMM, enter the IP or Hostname of the SCVMM server for HP 3PAR StoreServ storage.

**SCVMM Server**

Enter the IP or Hostname

---

**NOTE:** You can modify the **Community String** for HP StoreVirtual Storage system. You can only modify the **IP address** for HP StoreEasy 5000 Storage, HP E5000 Storage systems, and HP 3PAR StoreServ File Controller.

To modify SCVMM IP from gateway server or server in other domain, connect using System Center Virtual Machine Manager domain credentials.

---

## Removing discovered HP Storage device from the HP Storage Management Pack user configuration tool

1. Select the HP Storage Device that needs to be removed and click **Remove HP Storage System** link in the Actions panel.
2. Select the storage device from the list and click **Remove**.

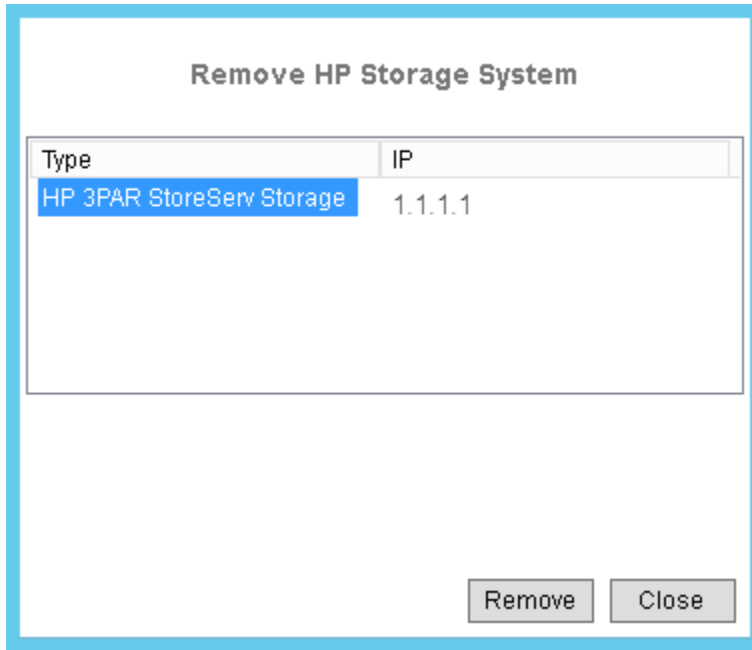

3. Once the storage system is removed successfully, the storage entry is removed from the dashboard.

## Configuring the Management Pack for HP 3PAR StoreServ Storage

### Processing Events/Alerts for HP 3PAR StoreServ Storage

---

**NOTE:** Follow the steps mentioned in “[Getting SNMP Traps from HP 3PAR StoreServ Storage](#)” (page 86) to register the OpsMgr to the SNMP agent of the HP 3PAR StoreServ Storage.

---

Once the HP 3PAR StoreServ Storage Management Pack is imported into OpsMgr to receive traps from the 3PAR StoreServ device, perform the following steps:

1. Launch the **OpsMgr** console.
2. Click the **Authoring** pane to display the Authoring console. In the Authoring console, click **Object Discoveries**.
3. Search for **HP 3PAR StoreServ SNMP Trap Catcher Rule** using the **Look for:** search bar in the **Object Discoveries** window.
4. Right-click the **HP 3PAR StoreServ SNMP Trap Catcher Rule** and select **Overrides+Override the Object Discovery**. Select the option **For a specific object of the class: Windows Computer**.
5. Override the rule for a particular OpsMgr Server Computer Object (a list that includes all OpsMgr servers as members). The rule is activated at the OpsMgr server and SNMP traps are received.
6. Select the override property after selecting the object, and change the override setting from **False** to **True**. Click **OK** to save. You can save it either in Custom Management Pack or in Default Management Pack.

**NOTE:** It is recommended to save the override settings to a custom Management Pack instead of the Default Management Pack.

Follow the steps to save the override setting in custom Management Pack:

- Click **New** in the Override Properties dialog.
- Enter the name of custom management pack in the text-box, click **Next** and select **Create**.

This will avoid creating dependency between Default Management Pack and HP 3PAR StoreServ Management Pack for System Center.

7. Click **Monitoring** pane to display the Events and Alerts.
8. Click **Events** in the **HP 3PAR StoreServ Storage** folder. The Events and Alerts of the HP 3PAR StoreServ are displayed.

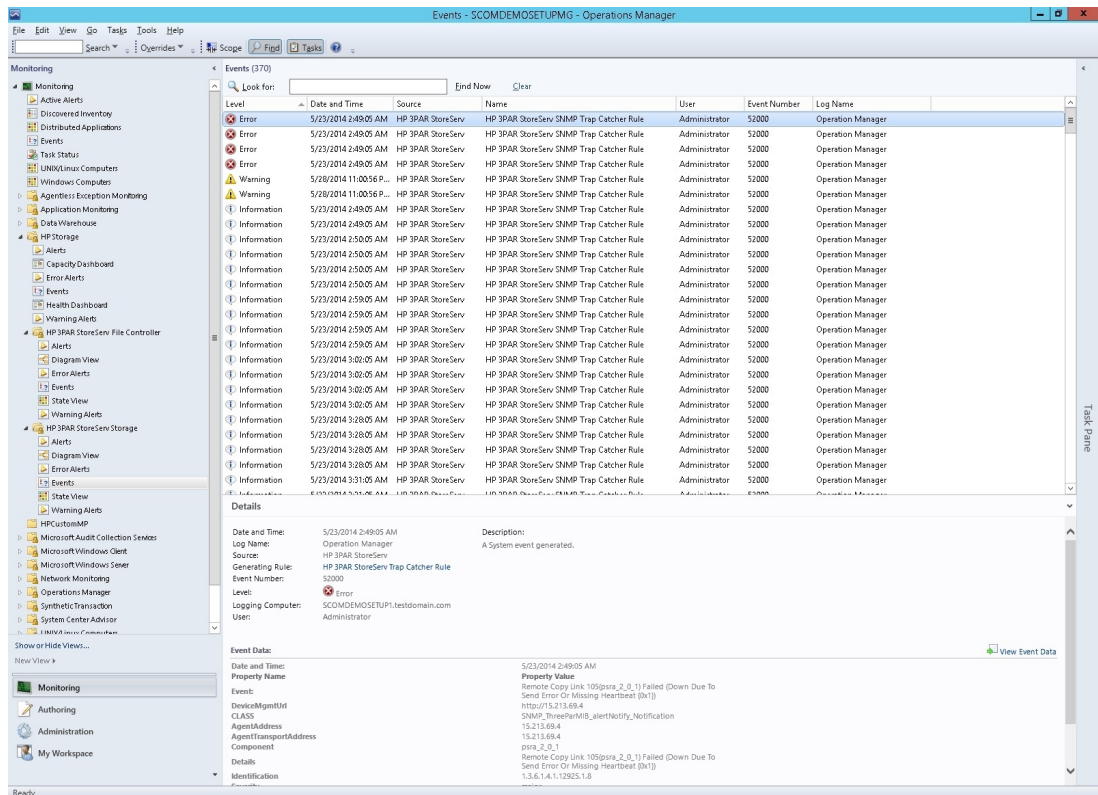

## Diagram View of the HP 3PAR StoreServ Storage

Diagram View displays the diagrammatic representation of the HP 3PAR StoreServ Storage. It displays the information in a four level hierarchy as follows:

1. The first level displays the HP 3PAR StoreServ Storage group. All the HP 3PAR Storage discovered will be displayed under this group.
2. The second level displays the HP 3PAR StoreServ Storage with name and description.
3. The third level displays the groups for component type of HP 3PAR StoreServ Storage. The component types are grouped as Provisioning, Systems, and Virtualization.
4. The fourth level displays the component group for each component type.

Component Type	Component Group Name
Provisioning	CPGs Virtual Volumes

Systems	Batteries Controller Nodes Drive Cages Physical Disks Ports Power Supplies System Fans
Virtualization	Virtual Machines

**NOTE:**

- Some of the HP 3PAR StoreServ Storage Systems does not have System Fans. For those systems System Fans component will not be shown.
- To avoid clutter in the diagram view, warning or critical state objects are displayed for **Physical Disks, CPGs, Virtual Volumes** and **Virtual Machines**. To verify the total number of objects, select the component group and check details.
- To view **Virtual Machines** information in the **Diagram View** , perform the following steps:
  - Install System Center Virtual Machine Manager Console 2012 R2 on the computer where System Center Operations Manager 2012 R2 management server is installed. After installation, open the Virtual Machine Manager Console and connect to the respective SCVMM server.
  - Configure HP 3PAR StoreServ Storage and SCVMM Server IP in User Configuration tool, for more info see [Discovery of HP Storage devices using HP Storage Management Pack User Configuration Tool](#) For more information see [Installation prerequisites](#) .
- In the Diagram View, Hyper-V and ESX Virtual machines and their health status are displayed based on the following conditions:
  - If they are managed by SCVMM
  - If they are created from HP 3PAR StoreServ Storage
  - If HP 3PAR StoreServ Storage is monitored by SCOM

5. The fifth level displays the respective instances of each component.

Perform the following steps to see the Diagram View of the HP 3PAR StoreServ Storage:

1. Discover the HP 3PAR StoreServ Storage using the HP Storage Management Pack User Configuration Tool. For more information, see [“Discovery of HP Storage devices using HP Storage Management Pack User Configuration Tool”](#) (page 44).

**NOTE:** If HP Storage Management Pack upgraded from v4.0 to v4.1 , modify the HP 3PAR Storage discovered with same credentials using HP Storage Management Pack User Configuration Tool to reconfigure.

2. Click **Authoring pane** after discovering the HP 3PAR StoreServ Storage. It displays the Authoring console.
3. Select **Object Discoveries** and type **3PAR StoreServ** in the **Look For:** textbox, and click **Find Now**.
4. The two 3PAR rules are displayed.

Right-click on **HP 3PAR StoreServ Storage Discovery Rule** and select **Override** → **Override the Object Discovery** → **For specific objects of the class: Windows Computer**.

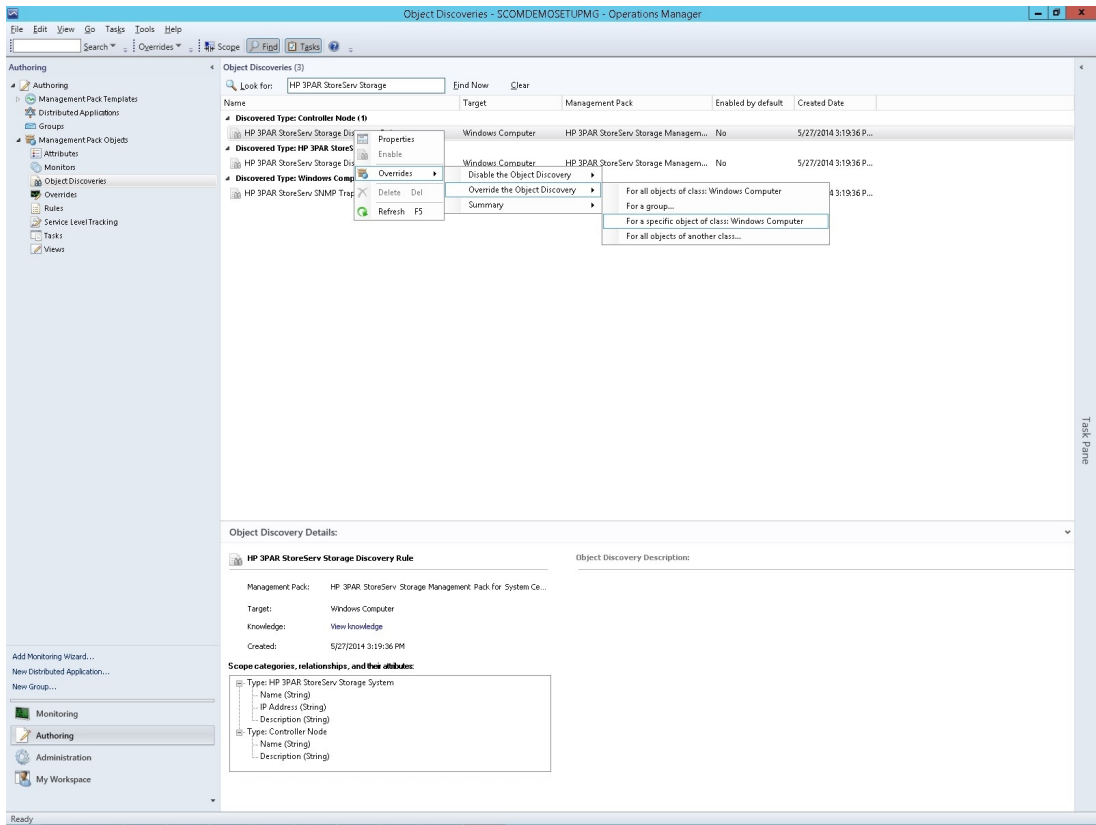

**NOTE:** Enabling one discovery rule for a device will automatically enable the other discovery rule.

5. Select the object where the HP 3PAR StoreServ Storage is discovered using HP Storage Management Pack User Configuration Tool and click **OK**.

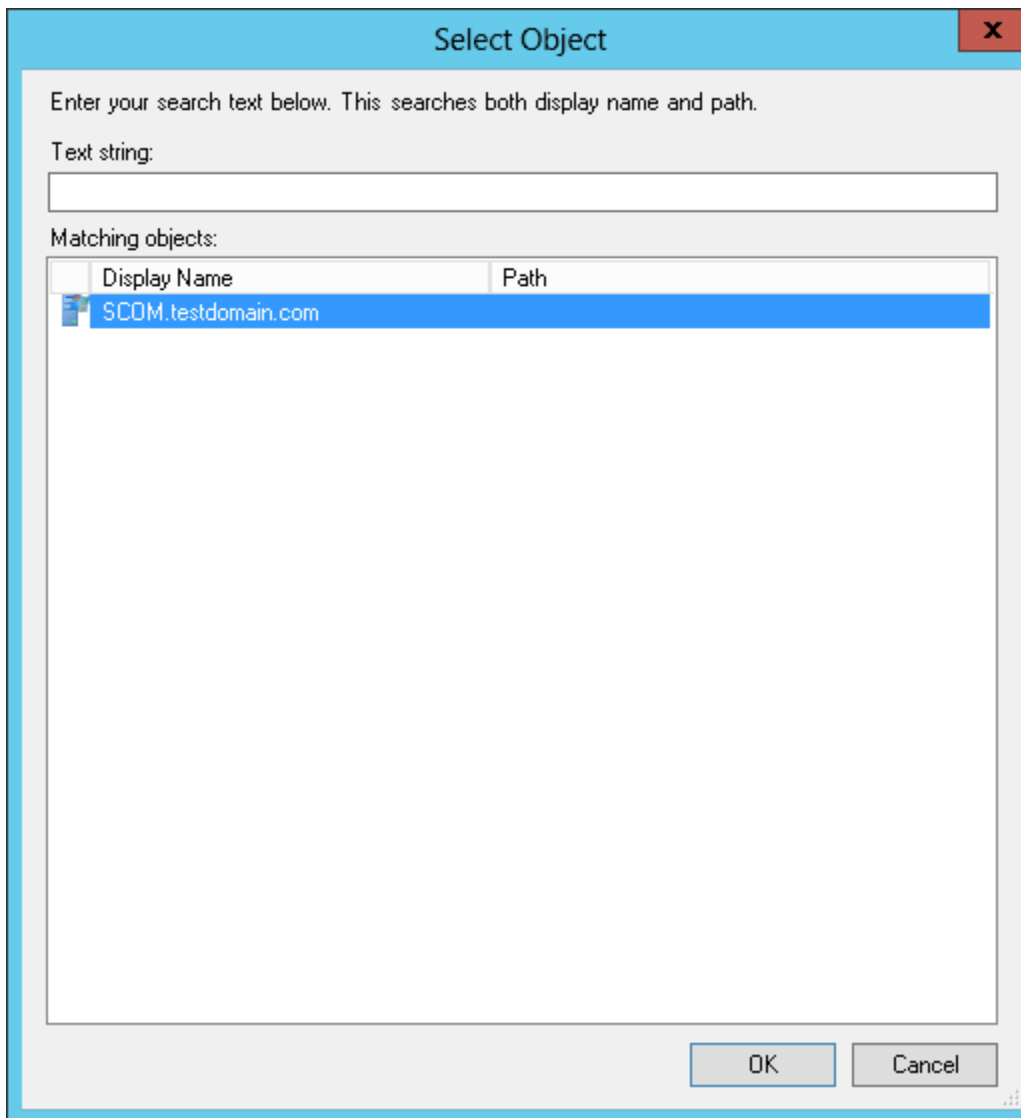

6. Select **Enable** checkbox and set the Override Value to **True**.

---

**NOTE:** By default, the Override value is set to 600 seconds, where the rule takes 600 seconds to apply. Also, the Diagram View will refresh in every 600 seconds. You can specify a minimum of 150 seconds or a maximum of 300 seconds as the override value.

For example, if you change the override value to 150 seconds, then the rule will take 150 seconds to apply and the Diagram View will refresh in every 150 seconds. In case you change the Override Value, navigate to the last option, select the destination Management Pack on the page and click **New**. Type a name for the management pack and click **Save**.

---

7. Click **OK**.
8. Click **Monitoring pane** to display the Monitoring console.

- Click **Diagram View** in the **HP 3PAR StoreServ Storage** folder. The Diagram view of the HP 3PAR StoreServ Storage System is displayed.

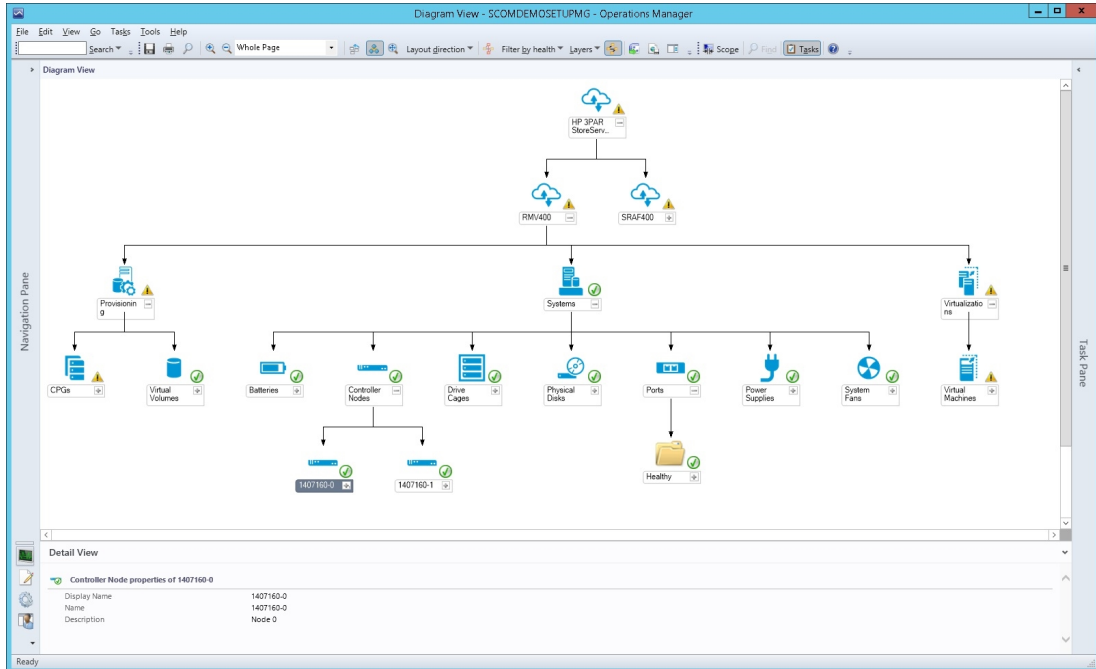

## Capacity Dashboard for HP 3PAR StoreServ Storage

The **Capacity Dashboard** displays the capacity details for the following components discovered for HP 3PAR StoreServ Storage:

- Storage System
- CPG
- Virtual Volumes

**NOTE:** On the launch of the OpsMgr console on management server, the dashboard will be connected to default Management Server. The user can connect to any other management server by editing the textbox and clicking on the connect button. However when OpsMgr console is launched on any other server other than management server, appropriate message will be prompted to user to enter the Management Server IP or hostname and click on Connect to connect to the appropriate Management Server. Once connected to a management server, the selection will be retained.

After the installation of HP 3PAR StoreServ Storage management pack, the **Capacity Dashboard** view is created under the **HP Storage** folder. To display information in the **Capacity Dashboard**, configure HP 3PAR StoreServ Storage using the User Configuration Tool.

The capacity dashboard displays data in tabular and graphical format. The current capacity is displayed in the tabular format and the historical capacity is displayed in the graphical format.

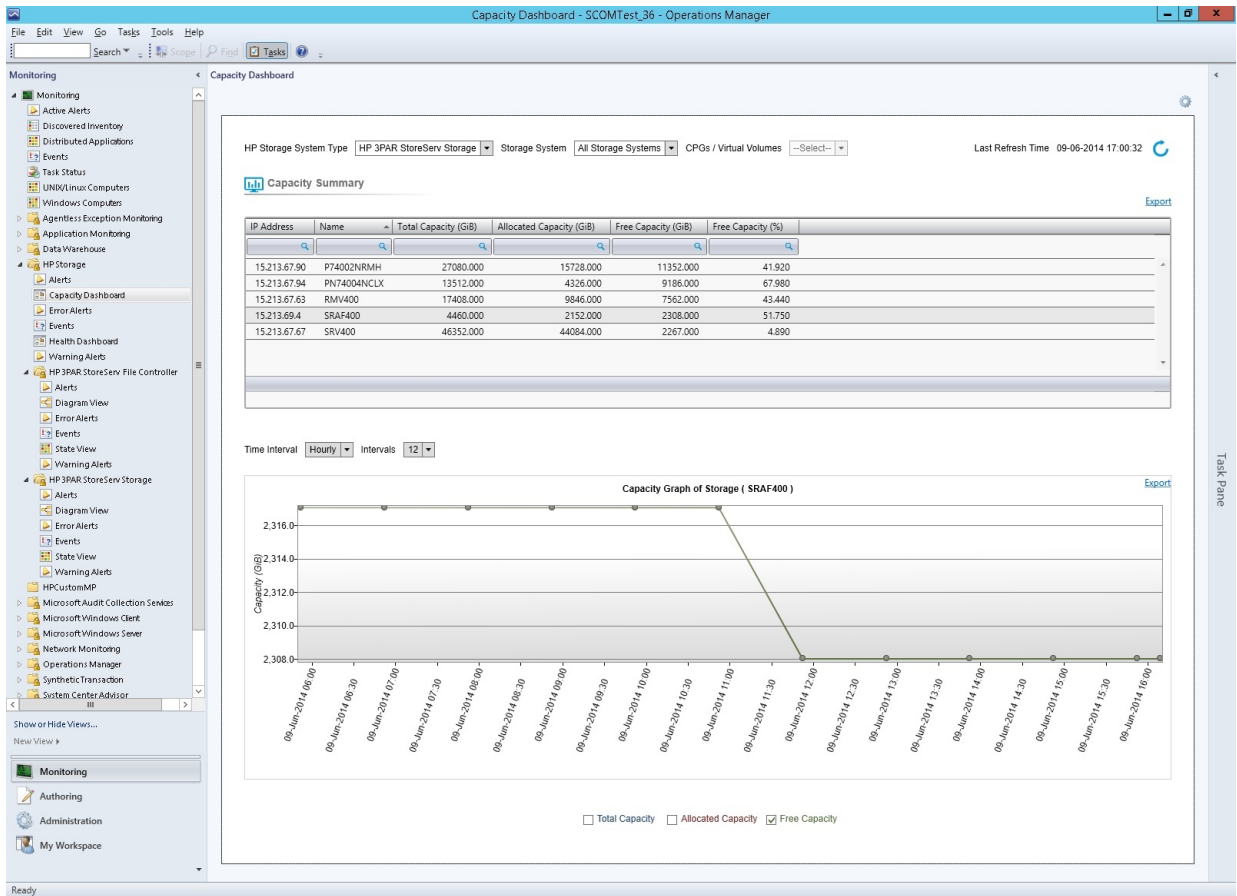

## Tabular representation of Capacity Summary

The Table 5 (page ?) lists capacity for Storage Systems, CPGs and Virtual Volumes. Capacity information is displayed in GiB units. The following table provides options to display the capacity details:

**Table 5 Capacity Details**

Component name	Steps performed	Description	Fields displayed
Storage Systems	<ol style="list-style-type: none"> <li>From the <b>HP Storage System Type</b> list, select <b>HP 3PAR StoreServ Storage</b>.</li> <li>From the <b>Storage System</b> list, select <b>All Storage Systems</b>.</li> </ol>	Displays capacity summary for HP 3PAR StoreServ Storage configured using User Configuration Tool.	<p>The following information is displayed in the <b>Capacity Summary</b> table for Storage Systems:</p> <ul style="list-style-type: none"> <li>IP Address</li> <li>Name</li> <li>Total Capacity</li> <li>Allocated Capacity</li> </ul>



**Table 5 Capacity Details** (continued)

Component name	Steps performed	Description	Fields displayed
			<ul style="list-style-type: none"> <li>Free Capacity</li> <li>Percentage Free Capacity</li> </ul>
CPG	<ol style="list-style-type: none"> <li>From the <b>HP Storage System Type</b> list, select <b>HP 3PAR StoreServ Storage</b>.</li> <li>From the <b>Storage System</b> list, select <b>All Storage Systems</b>.</li> <li>From the <b>CPGs / Virtual Volumes</b> list, select <b>CPGs</b>.</li> </ol>	Displays capacity summary for the CPGs configured in the selected HP 3PAR StoreServ Storage.	The following information is displayed in the <b>Capacity Summary</b> table for CPGs: <ul style="list-style-type: none"> <li>Name</li> <li>Allocated Capacity</li> <li>Used Capacity</li> <li>Free Space</li> </ul>
Virtual Volume	<ol style="list-style-type: none"> <li>From the <b>HP Storage System Type</b> list, select <b>HP 3PAR StoreServ Storage</b>.</li> <li>From the <b>Storage System</b> list, select <b>All Storage Systems</b>.</li> <li>From the <b>CPGs / Virtual Volumes</b> list, select <b>Virtual Volumes</b></li> </ol>	Displays capacity summary for the Virtual Volumes configured in the selected HP 3PAR StoreServ Storage.	The following information is displayed in the <b>Capacity Summary</b> table for Virtual Volumes: <ul style="list-style-type: none"> <li>Name</li> <li>Provisioning</li> <li>Type</li> <li>Copy Of</li> <li>User Space</li> <li>Admin Space</li> <li>Copy Space</li> <li>Total Reserve Space</li> <li>Virtual Size</li> </ul>

You can perform operations, such as search, sort, or filter to find specific components.

To view the latest capacity information, click refresh . When you click refresh, only the data in the table is refreshed. The graphical data is refreshed only after the next poll cycle.

### Graphical representation of Capacity Summary

The graphical data is the historical data obtained during a specific time period. It displays the change in capacity for a selected time period.

**NOTE:** Capacity information for the graph is queried every hour. The graph is displayed three hours after the installation. When a new CPG or Virtual Volume is created, the data is captured from the next poll cycle.

The minimum time interval required to display a graph is an hour and the maximum data that is displayed is 96 months.

To view the graph for a component, select the component in the **Capacity Summary** table, and select the time period from **Time Interval** and **Intervals**.

For example, to display the graph for last **12** hours, select **Time Interval** as **Hourly** and **Interval** as **12**.

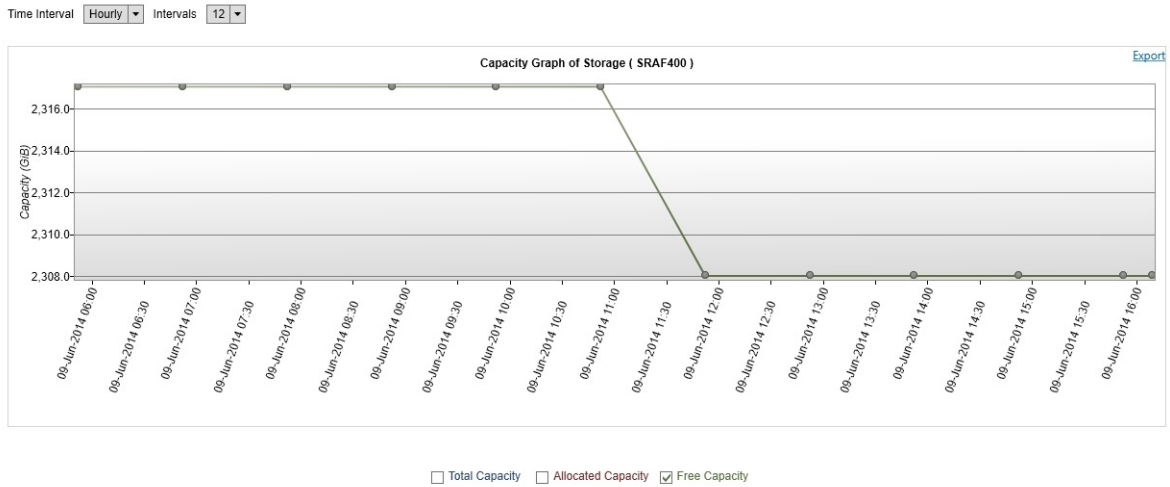

**NOTE:** The graph displays the selected attributes based on the component and option selected. You can select multiple or all attributes.

To export the table or graphical data into a CSV file format, click **Export**.

## Health Dashboard for HP 3PAR StoreServ Storage

After the installation of HP 3PAR StoreServ Storage management pack, the Health Dashboard view is created under the HP Storage folder. The Health Dashboard displays Health Summary and Alert Summary.

The Health Summary displays the health details for components discovered for HP 3PAR StoreServ Storage configured using the User Configuration Tool. The Alert Summary displays the warning and critical alerts for selected HP 3PAR StoreServ Storage.

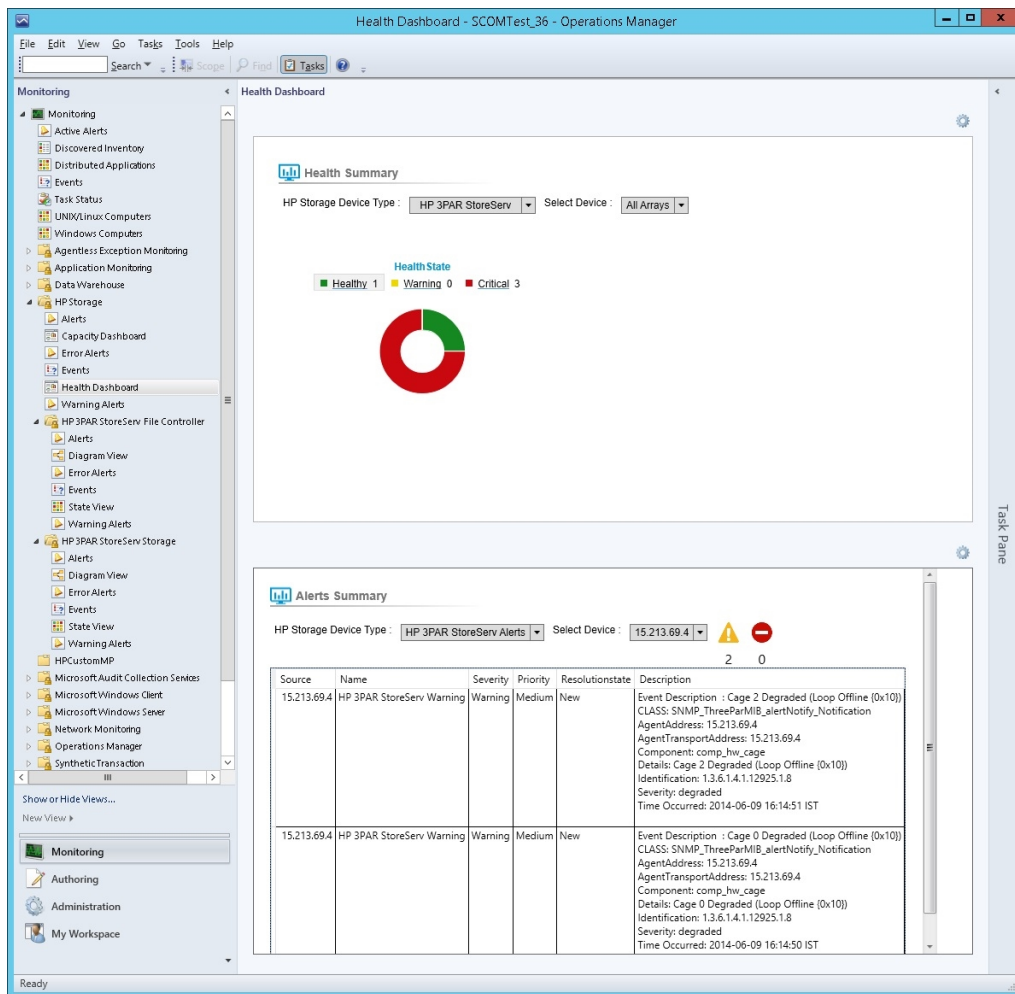

**NOTE:** If OpsMgr console is launched on any other server other than OpsMgr management server make sure Management Server IP connected in Capacity dashboard before launching the Health dashboard.

## Health Summary

Health summary displays the health state of HP 3PAR StoreServ Storage and its components. The health state table provides information on the steps you must perform to view the the health state of specific components of HP 3PAR StoreServ discovered perform the following:

**Table 6 Health State**

Component label	Steps performed	Description
All Storage Systems	<ol style="list-style-type: none"> <li>1. From the <b>HP Storage System Type</b> list, select <b>HP 3PAR StoreServ</b>.</li> <li>2. From the <b>Select Device</b> list, select <b>All Arrays</b>.</li> </ol>	Displays health summary for the HP 3PAR StoreServ Storage configured using User Configuration Tool. The following image represents the health summary for all arrays.

**Table 6 Health State** (continued)

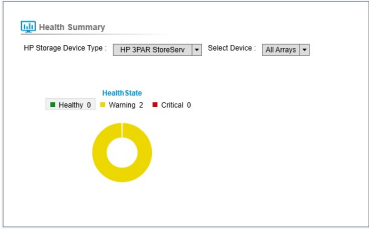
Component label	Steps performed	Description
		
Systems/Provisioning/Virtualization Components	<ol style="list-style-type: none"> <li>From the <b>HP Storage System Type</b> list, select <b>HP 3PAR StoreServ</b>.</li> <li>From the <b>Select Device</b> list, select IP of the Storage System.</li> </ol>	<p>Displays health summary for the HP 3PAR StoreServ Storage Systems/Provisioning/Virtualization Components discovered for the selected storage system.</p> <p>The following image represents the health summary for Systems/Provisioning/Virtualization Components.</p> 

### Alert Summary

Alert summary displays the critical and warning alerts for HP 3PAR StoreServ Storage. You can also view the count of warning and critical alerts generated by the specific HP 3PAR StoreServ Storage.

For information on configuring HP 3PAR StoreServ storage alerts see [Processing Events/Alerts for HP 3PAR StoreServ Storage](#)

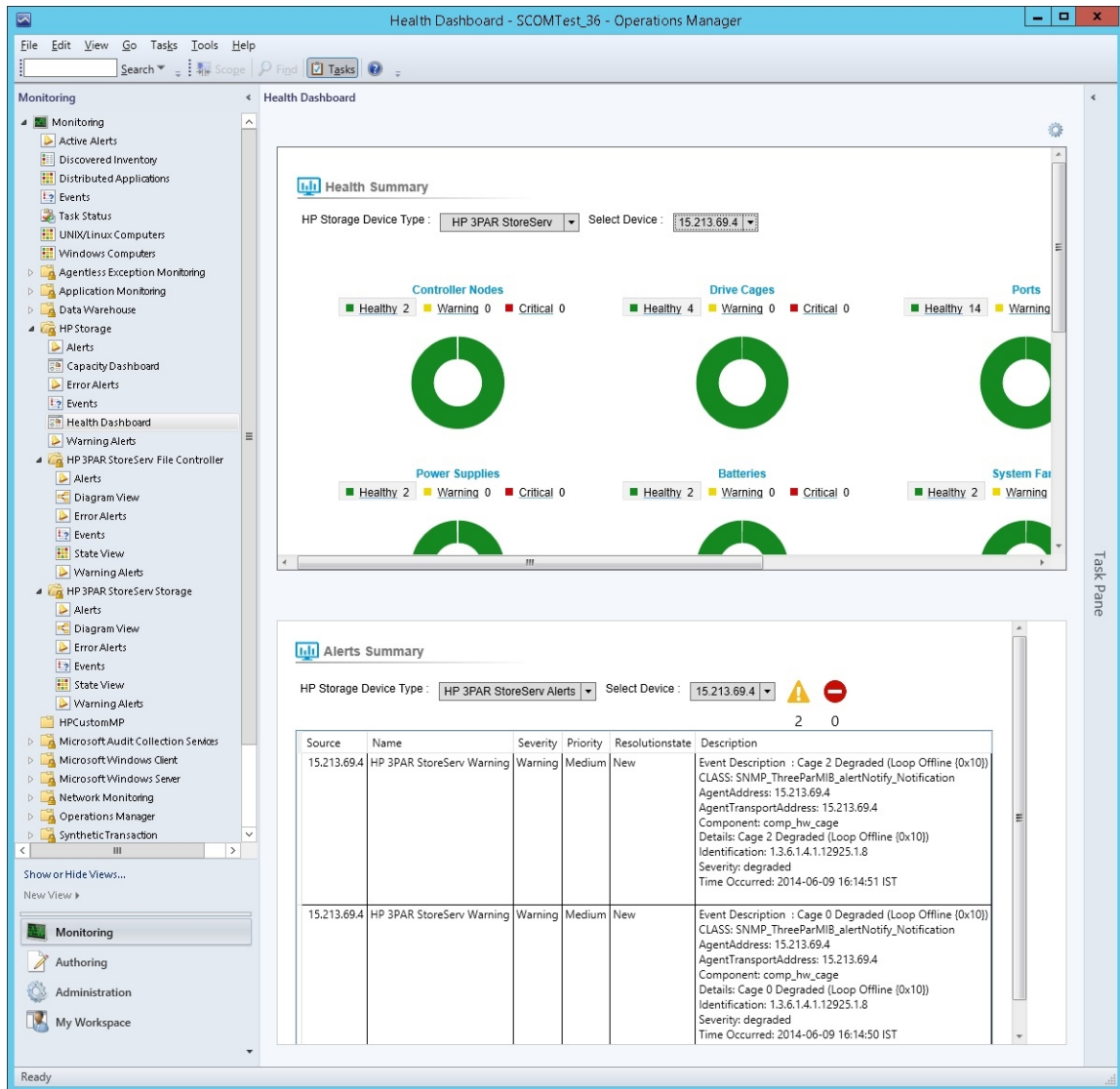

To view the alerts details of the HP 3PAR StoreServ storage:

1. In **HP Storage Device Type**, select **HP 3PAR StoreServ Alerts**.

2. Select Warning /Critical  respectively.

The following details are displayed:

- Source – Represents IP address of HP 3PAR StoreServ
- Name – Represents the rule name of HP 3PAR StoreServ
- Severity – Represents the severity of an alert
- Priority – Represents the priority of the generated alert
- Resolutionstate – Represents the resolution state of an alert
- Description – Represents the detail alert description

## Accessing Capacity Dashboard from a remote OpsMgr Console

When OpsMgr console is launched from any server other than the management server, you must enter the Management Server IP or hostname and click on **Connect**. You can connect to another management server by editing the text box and clicking on the connect.

Connected to the Management Server :

## Configuring the Management Pack for HP StoreVirtual Storage

### Processing Events/Alerts for HP StoreVirtual Storage

**NOTE:** Follow the steps mentioned in “Getting SNMP traps from HP StoreVirtual Storage System” (page 87) to register the OpsMgr to the SNMP agent of the HP StoreVirtual Storage.

Once the HP StoreVirtual Storage Management Pack for System Center is imported into OpsMgr to receive traps from the StoreVirtual device, perform the following steps:

1. Launch the OpsMgr console.
2. Click the **Authoring** pane to display the Authoring console. In the Authoring console, click **Object Discoveries**.
3. Search for **HP StoreVirtual SNMP Trap Catcher Rule** using the **Look for:** search bar in the **Object Discoveries** window.
4. Right-click the **HP StoreVirtual SNMP Trap Catcher Rule** and select **Overrides**→**Override the Object Discovery**. Select the option **For a specific object of the class: Windows Computer**.
5. Override the rule for a particular OpsMgr Server Computer Object (list that includes all OpsMgr servers as members). The rule is activated at the OpsMgr server and SNMP traps are received.
6. Select the override property after selecting the object, and change the override setting from **False to True**. Click **Ok** to save it to the Default Management Pack.
7. Click **Monitoring** pane to display the Events and Alerts.
8. Click **Events** in the **HP StoreVirtual Storage** folder. The Events and Alerts of the HP StoreVirtual is displayed.

**NOTE:** It is recommended to save the override settings to a custom Management Pack instead of the Default Management Pack. Follow the steps to save the override setting in custom Management Pack:

1. Click **New** in the **Override Properties** dialog box.
2. Enter the name of custom management pack in the text-box, click **Next** and select **Create**. This will avoid creating dependency between Default Management Pack and HP StoreVirtual Storage Management Pack.

### Diagram View of the HP StoreVirtual Storage

Diagram View displays the diagrammatic representation of the HP StoreVirtual Storage. It displays the information in a six level hierarchy as follows:

1. The first level displays the HP StoreVirtual Storage group.
2. The second level displays the Management Group of HP StoreVirtual Storage. All HP StoreVirtual Storage managed by the HP Storage Management Pack User Configuration Tool are displayed.
3. The third level displays the clusters of HP StoreVirtual Storage.

- The fourth level displays the Physical group, Logical and Virtual group to display all the HP StoreVirtual Storage in a cluster.

The following HP StoreVirtual components are monitored:

**Table 7**

Component Type	Component Group
Physical	Drives Fans Network Device Power Supply Controller Cache and Cache Battery Backup Unit
Logical	Volumes and Snapshots Group and its sub components
Virtual	HP StoreVirtual VSA and its sub components

**NOTE:** Make sure manager state of all HP StoreVirtual Appliance and VSA belonging to cluster are in running.

Perform the following steps to see the Diagram View of the HP StoreVirtual Storage:

- Discover the HP StoreVirtual Storage using the HP Storage Management Pack User Configuration tool. For more information, see [“Discovery of HP Storage devices using HP Storage Management Pack User Configuration Tool”](#) (page 44).

**NOTE:** Ensure HP StoreVirtual Storage discovered using HP Storage Management Pack User Configuration Tool v4.0 is removed and rediscovered using HP StoreVirtual Storage Cluster IP.

- Click **Authoring** pane after you discover the StoreVirtual Storage. It displays the Authoring console.
- Select **Object Discoveries**.
- To discover the HP StoreVirtual Storage System, do one of the following:
  - Search for **HP StoreVirtual Discovery Rule** using the **Look for:** search bar in the **Object Discoveries** window.
  - Right-click the **HP StoreVirtual Discovery Rule** and select **Override**→**Override the Object Discovery**
  - For specific objects of the class: Windows Computer.**
  - Select the object where the StoreVirtual Storage is discovered using HP Storage Management Pack User Configuration Tool and click **OK**.
  - Select **Enable checkbox** and set the Override Value to **True**.
  - Change the interval seconds of the rule appropriately.
  - Click **OK**.

**NOTE:** By default, the Override value is set to 1800 seconds, where the rule takes 1800 seconds to apply. Also, the Diagram View will refresh in every 1800 seconds. You can specify a minimum of 300 seconds or a maximum of 600 seconds as the override value. For example, if you change the override value to 300 seconds, then the rule will take 300 seconds to apply and the Diagram View will refresh in every 300 seconds. In case you change the Override Value, navigate to the last option, select the destination Management Pack on the page and click New. Type a name for the management pack and click Save.

5. Click Monitoring pane to display the Monitoring console.
6. Click **Diagram View** in the **HP StoreVirtual Storage** folder. The Diagram View of the HP StoreVirtual Storage with the health state is displayed.

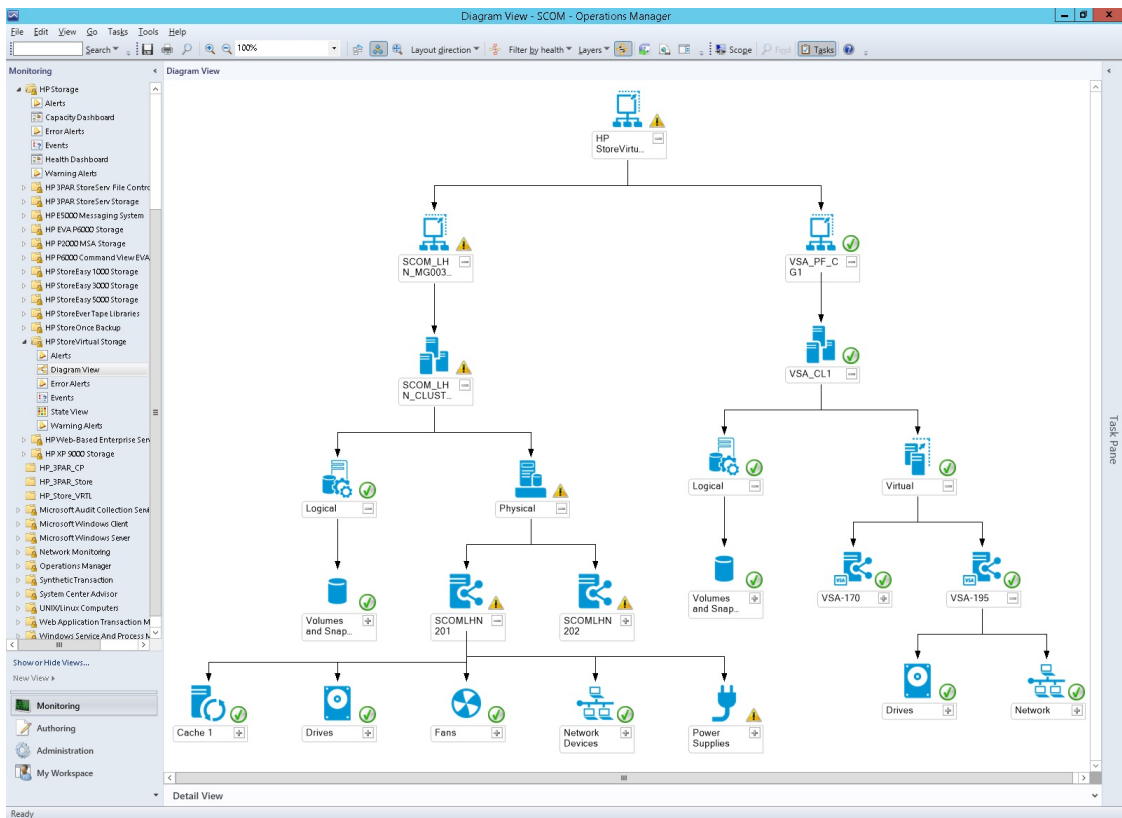

## Configuring the Management Pack for HP 3PAR StoreServ File Controller Processing Events/Alerts for HP 3PAR StoreServ File Controller

**NOTE:** Follow the steps mentioned in [Discovery of HP 3PAR StoreServ File Controller](#) to configure HP 3PAR StoreServ File Controller to receive the events in OpsMgr.

After installation of HP 3PAR StoreServ File Controller Management Pack, to receive WMI events from the 3PAR StoreServ file controller system, perform the following steps:

1. Launch the OpsMgr console.
2. Click the **Authoring** pane to display the Authoring console. In the Authoring console, click **Object Discoveries**.
3. Search for **HP 3PAR StoreServ File Controller Event Discovery Rule** using the **Look for:** search bar in the **Rules** window.
4. Right-click the "HP 3PAR StoreServ File Controller Event Discovery Rule and select **Overrides**→**Override the Rule**.
5. Select For a specific object of the class: **Windows Computer**.
6. Override the rule for a particular HP 3PAR StoreServ File Controller system. The rule is activated at the OpsMgr server, and WMI events are received.
7. Select the override property after selecting the HP 3PAR StoreServ File Controller system, and change the override setting from **False** to **True**. Click **Ok** to save it to the Default Management Pack.



**NOTE:** It is recommended to save the override settings to the Custom Management Pack instead of the Default Management Pack.

Follow the steps to save the override setting in the Custom Management Pack:

- Click New in the Override Properties dialog box.
- Enter the name of custom management pack in the text-box, click Next and select Create.
- This avoids the need to create dependency between Default Management Pack and HP 3PAR StoreServ File Controller Management Pack for System Center.
- 

8. Click Monitoring pane to display the Events and Alerts.

9. Click Events in the HP 3PAR StoreServ File Controller folder. The Events and Alerts of the HP 3PAR StoreServ File Controller events are displayed.

The screenshot shows the 'Alerts - OM - Operations Manager' window. The left-hand 'Monitoring' pane is expanded to 'HP 3PAR StoreServ File Controller' > 'Alerts'. The main area displays a table of alerts:

Severity	Path	Source	Name	Resolution State	Created	Age
Critical (5)	STOREEASYP2...	STOREEASYP2...	HP 3PAR StoreServ File Controller Error	New	28-05-2014 11:45:58	2 Days, 18 Hour...
Warning (3)	STOREEASYP2...	STOREEASYP2...	HP 3PAR StoreServ File Controller Warning	New	28-05-2014 11:45:44	2 Days, 18 Hour...

The 'Alert Details' pane for the selected error alert shows:

- Alert Description:** A fan has failed. (6)
- Source:** STOREEASYP2.testdomain.com
- Full Path Name:** STOREEASYP2.testdomain.com\STOREEASYP2.testdomain.com
- Alert Rule:** HP 3PAR StoreServ File Controller Fan Failed Rule
- Created:** 28-05-2014 11:45:58
- User Action:** Check the failed fan and replace if necessary.
- WBEM Indication Properties:** AlertingElementFormat: 2.0x2 (CIMObjectPath), AlertingManagedElement: "\STOREEASYP2\W007HPQHP\_WinFan.CreationClassName='HP\_WinFan',DeviceID='Fan 3',SystemCreationClassName='HP\_WinComputerSystem',SystemName='STOREEASYP2.testdomain.com'", AlertTypes: 5.0x5 (Device Alert), Description: "A fan has failed. (6)", EventCategory: 23.0x17 (System Cooling), EventID: "3", ImpactedDomain: 4.0x4 (System), IndicationIdentifier: "18809E1B1-872A-4E03-8D54-7D4852E41C1D", IndicationTime: "20140528114558.007000+330", NetworkAddresses[0]: "15.218.170.128", NetworkAddresses[1]: "15.218.168.41", NetworkAddresses[2]: "15.218.168.42", OSType: 116.0x74 (Microsoft Windows Server 2012 R2), OSVersion: "6.3.9600", PerceivedSeverity: 5.0x5 (Major), ProbableCause: 94.0x5e (Fan Failure), ProbableCauseDescription: "Fan Failed", ProviderName: "HP\_Cooling", ProviderVersion: "9.5.0.0", RecommendedActions[0]: "Check the failed fan and replace if necessary.", Summary: "Fan failed", SystemCreationClassName: "HP\_WinComputerSystem", SystemFirmwareVersion[0]: "2013.12.20", SystemFirmwareVersion[1]: "2013.12.20", SystemGUID: "30583745-4132-4753-4854-303843464131", SystemModel: "3PAR StoreServ File Controller".

## Diagram View of the HP 3PAR StoreServ File Controller

Diagram View displays the diagrammatic representation of the HP 3PAR StoreServ File Controller. It displays the information in a four level hierarchy as follows:

1. The first level displays the HP 3PAR StoreServ File Controller group. All the HP 3PAR StoreServ File Controller discovered will be displayed under this group.
2. The second level displays 3PAR StoreServ File Controller Cluster Disks, Network and Roles group.
3. The third level displays respective cluster disk, cluster network and the cluster roles of HP 3PAR StoreServ File Controller.

Perform the following steps to see the Diagram View of the HP 3PAR StoreServ File Controller:

1. Discover the HP 3PAR StoreServ File Controller using the HP Storage Management Pack User Configuration Tool.

For more information, see [Discovery of HP Storage devices using HP Storage Management Pack User Configuration Tool](#)

2. Select **Authoring** pane after you discover the HP 3PAR StoreServ File Controller.
3. Select **Object Discoveries**.

4. To discover the **HP 3PAR StoreServ File Controller Discovery** perform the following:

- Search for **HP 3PAR StoreServ File Controller Discovery Rule** using the **Look for:** search bar in the **Object Discoveries** window
- Right-click on **HP 3PAR StoreServ File Controller Discovery Rule** and select **Override**→**Override the Object Discovery**→**For specific objects of the class: Windows Computer**.
- Select the object where the HP 3PAR StoreServ File Controller is discovered using HP Storage Management Pack User Configuration Tool and click OK.
- Select **Enable** checkbox and set the Override Value to True.
- Select **OK**.

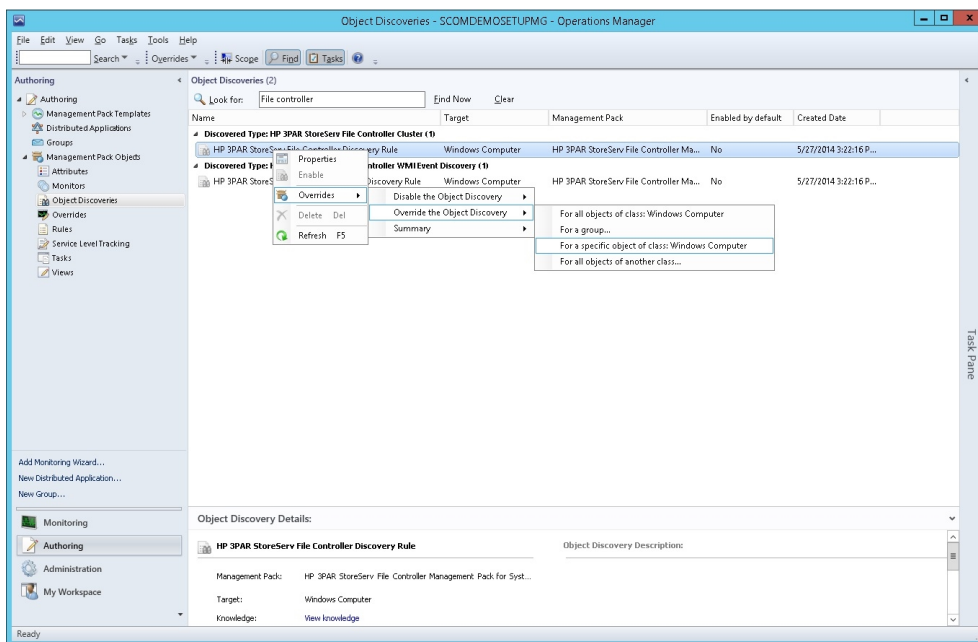

5. Select **Monitoring** pane to display the **Monitoring console**.
6. Select **Diagram View** in the **HP 3PAR StoreServ File Controller** folder. The **Diagram view** of **HP 3PAR StoreServ File Controller** is displayed.

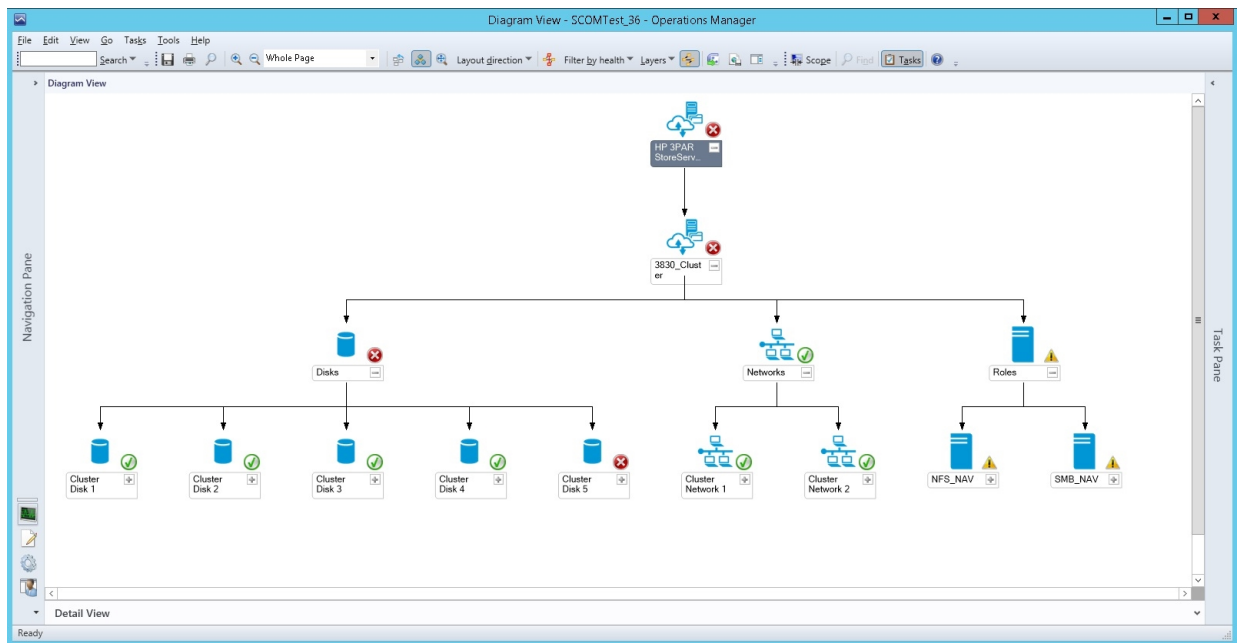

## Configuring the Management Pack for HP P2000 MSA Storage

### Processing Events/Alerts for HP P2000 MSA Storage

**NOTE:** Follow the steps mentioned in “Getting SNMP traps from HP P2000 MSA Storage” (page 88) to register the OpsMgr to the SNMP agent of the HP P2000 MSA Storage

Once the HP P2000 MSA Storage Management Pack is imported into OpsMgr to receive traps from the HP P2000 MSA device, perform the following steps:

1. Launch the OpsMgr console.
2. Click the **Authoring** pane to display the Authoring console. In the Authoring console, click **Object Discoveries**.
3. Search for **HP P2000 MSA SNMP Trap Catcher Rule** using the **Look for:** search bar in the **Object Discoveries** window.
4. Right-click the **HP P2000 MSA SNMP Trap Catcher Rule** and select **Overrides**→**Override the Object Discovery**. Select the option **For a specific object of the class: Windows Computer**.
5. Override the rule for a particular OpsMgr Server Computer Object (list that includes all OpsMgr servers as members). The rule is activated at the OpsMgr server and SNMP traps are received.
6. Select the override property after selecting the object, and change the override setting from **False** to **True**. Click **Ok** to save it either in the Custom Management Pack or in the Default Management Pack.

**NOTE:** It is recommended to save the override settings to the Custom Management Pack instead of the Default Management Pack.

Follow the steps to save the override setting in the Custom Management Pack:

- Click **New** in the **Override Properties** dialog box.
- Enter the name of custom management pack in the text-box, click **Next** and select **Create**.

This avoids the need to create dependency between Default Management Pack and HP P2000 MSA Management Pack for System Center.

7. Click **Monitoring** pane to display the Events and Alerts.

- Click **Events** in the **HP P2000 MSA Storage** folder. The Events and Alerts of the HP P2000 MSA is displayed.

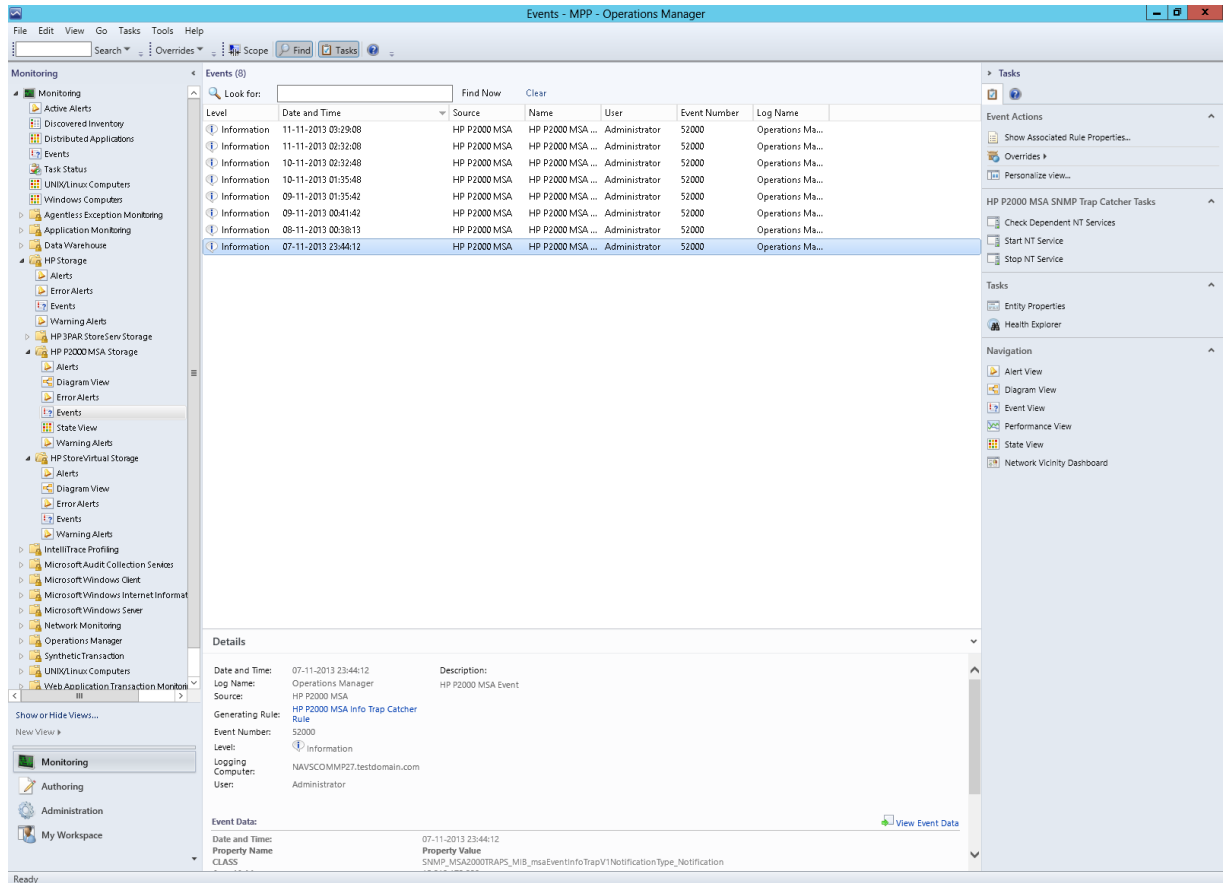

## Diagram View of the HP P2000 MSA Storage

Diagram View displays the diagrammatic representation of the HP P2000 MSA Storage. It displays the information in a four level hierarchy as follows:

- The first level displays the HP P2000 MSA Storage group. All the HP P2000 MSA Storage discovered will be displayed under this group.
- The second level displays the HP P2000 MSA Storage with name and description.
- The third level displays the component groups of the HP P2000 MSA Storage. The following HP P2000 MSA Storage components are monitored:

- Controllers
- Physical Disks
- Ports
- Power Supply

- The fourth level displays the respective components of each component group.

Perform the following steps to see the Diagram View of the HP P2000 MSA Storage:

- Discover the HP P2000 MSA Storage using the HP Storage Management Pack User Configuration Tool. For more information, see [“Discovery of HP Storage devices using HP Storage Management Pack User Configuration Tool”](#) (page 44).
- Click **Authoring pane** after discovering the HP P2000 MSA Storage. It displays the Authoring console.
- Select **Object Discoveries** and **Type P2000 MSA** in the **Look for:** textbox.

- The P2000 MSA rule is displayed.

Right-click the **HP P2000 MSA Storage Discovery Rule** and select **Override**→**Override the Object Discovery**→**For specific objects of the class: Windows Computer**.

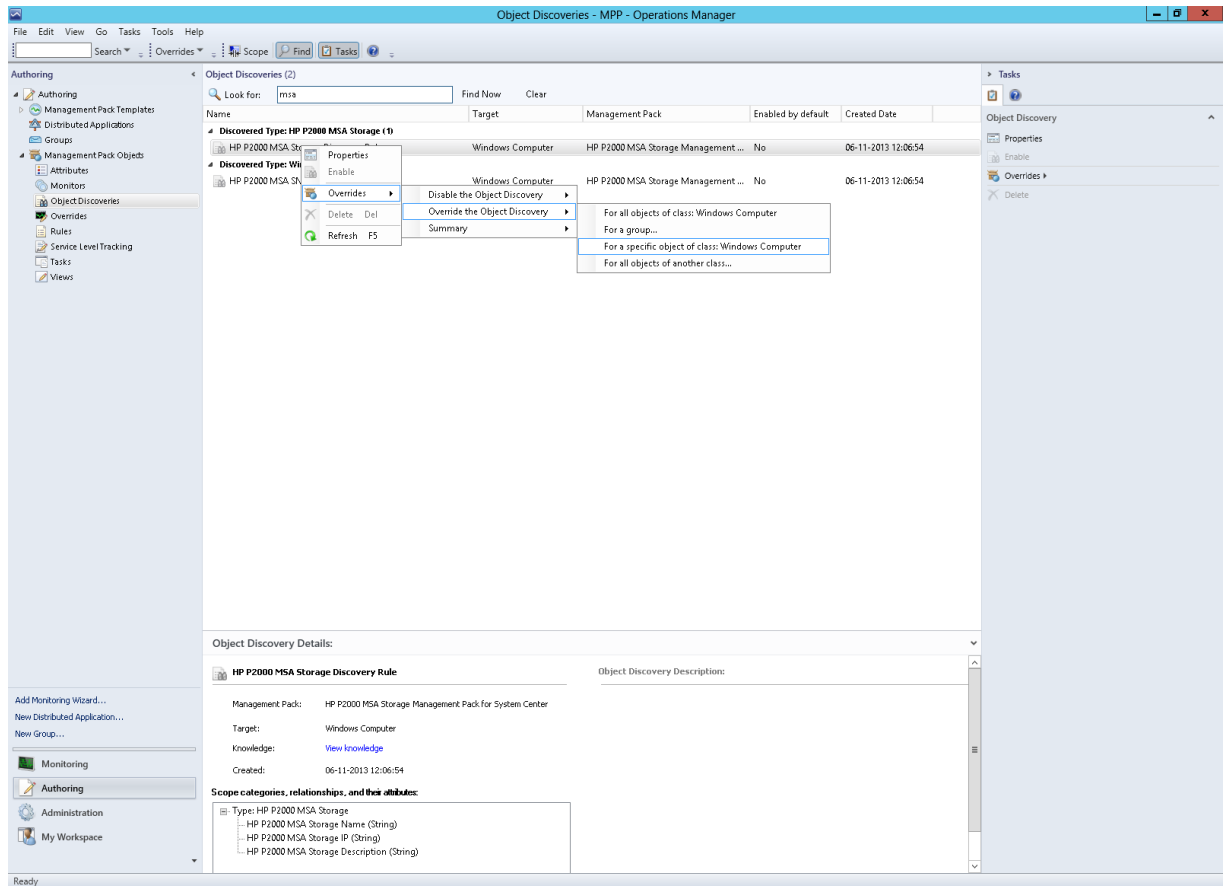

**NOTE:** Enabling one discovery rule for a device will automatically enable the other discovery rule.

- Select the object where the HP P2000 MSA Storage is discovered using HP Storage Management Pack User Configuration Tool and click **OK**.

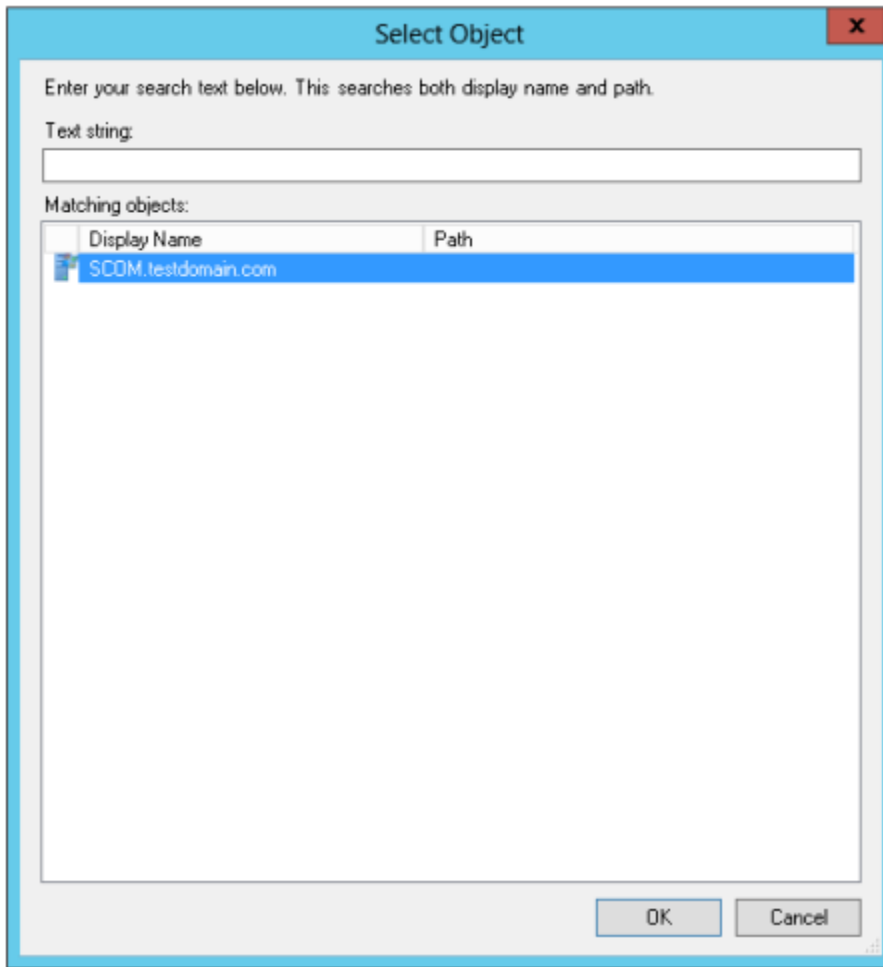

6. Select **Enable** checkbox and set the Override Value to **True**.

---

**NOTE:** By default, the Override value is set to 600 seconds, where the rule takes 600 seconds to apply. Also, the Diagram View will refresh in every 600 seconds. You can specify a minimum of 150 seconds or a maximum of 300 seconds as the override value.

For example, if you change the override value to 150 seconds, then the rule will take 150 seconds to apply and the Diagram View will refresh in every 150 seconds. In case you change the Override Value, navigate to the last option, select the destination Management Pack on the page and click **New**. Type a name for the management pack and click **Save**.

---

7. Click **OK**.
8. Click **Monitoring pane** to display the Monitoring console.

- Click **Diagram View** in the **HP P2000 MSA Storage** folder. The Diagram view of the HP P2000 MSA is displayed.

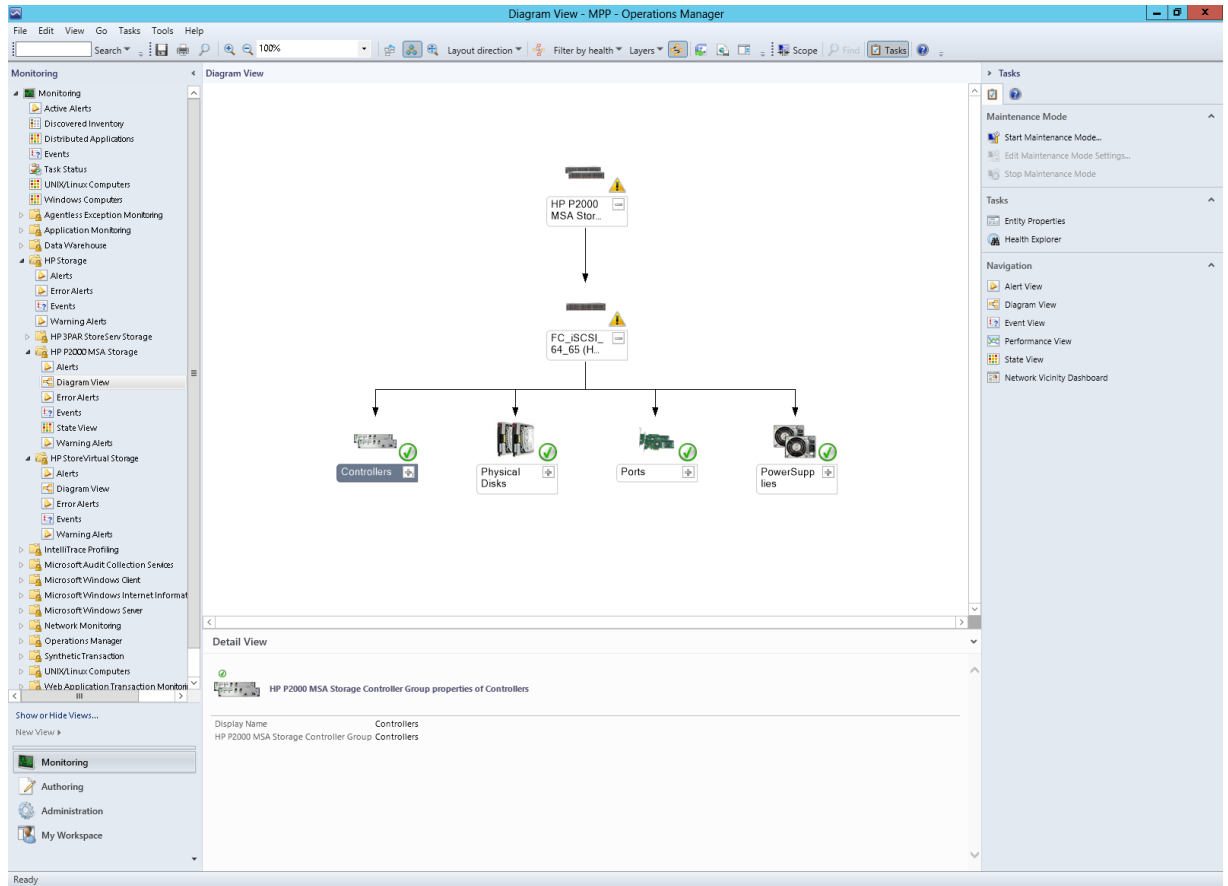

## Configuring the Management Pack for HP StoreEasy 5000 Storage

### Processing Events/Alerts for HP StoreEasy 5000 Storage

**NOTE:** Follow the “Discovery of HP StoreEasy 5000 Storage” (page 103) section to configure the StoreEasy 5000 to receive the events in OpsMgr:

To receive events and alerts through WMI for StoreEasy 5000 storage, configure the HP StoreEasy 5000 Storage Management Pack to process the WMI events and alerts. This option is disabled by default and requires manual creation of an Override Rule in the OpsMgr.

By default, the following two rules are disabled for StoreEasy 5000 Storage:

- HP StoreEasy 5000 Chassis Event Catcher Rule
- HP StoreEasy 5000 Cascade Event Catcher Rule

Once the HP StoreEasy 5000 Storage Management Pack is imported into OpsMgr to receive WMI events from the StoreEasy 5000 device, perform the following steps:

1. Launch the OpsMgr console.
2. Click the **Authoring** pane to display the Authoring console. In the Authoring console, click **Rules**.

3. Do one of the following:
  - Search for **HP StoreEasy 5000 Chassis Event Catcher Rule** using the **Look for:** search bar in the Rules window.
  - Right-click the **HP StoreEasy 5000 Chassis Event Catcher Rule** and select **Overrides**→**Override the Rule**.
  - Search for **HP StoreEasy 5000 Cascade Event Catcher Rule** using the **Look for:** search bar in the Rules window.
  - Right-click the **HP StoreEasy 5000 Cascade Event Catcher Rule** and select **Overrides**→**Override the Rule**.
4. Select **For a specific object of the class: HP StoreEasy 5000 Event Discovery Rule**.
5. Override the rule for a particular StoreEasy 5000 blade server. The rule is activated at the OpsMgr server and WMI events are received.

---

**NOTE:** Select only one blade server from HP StoreEasy 5000 Storage to avoid duplicate events.

---

6. Select the override property after selecting the StoreEasy 5000 blade server, and change the override setting from **False** to **True**. Click **Ok** to save it to the Default Management Pack.

---

**NOTE:** It is recommended to save the override settings to the Custom Management Pack instead of the Default Management Pack.

Follow the steps to save the override setting in the Custom Management Pack:

- Click **New** in the **Override Properties** dialog box.
  - Enter the name of custom management pack in the text-box, click **Next** and select **Create**.  
This avoids the need to create dependency between Default Management Pack and HP StoreEasy 5000 Management Pack for System Center.
- 
7. Click **Monitoring** pane to display the Events and Alerts.
  8. Click **Events** in the **HP StoreEasy 5000 Storage** folder. The Events and Alerts of the HP StoreEasy 5000 events are displayed.



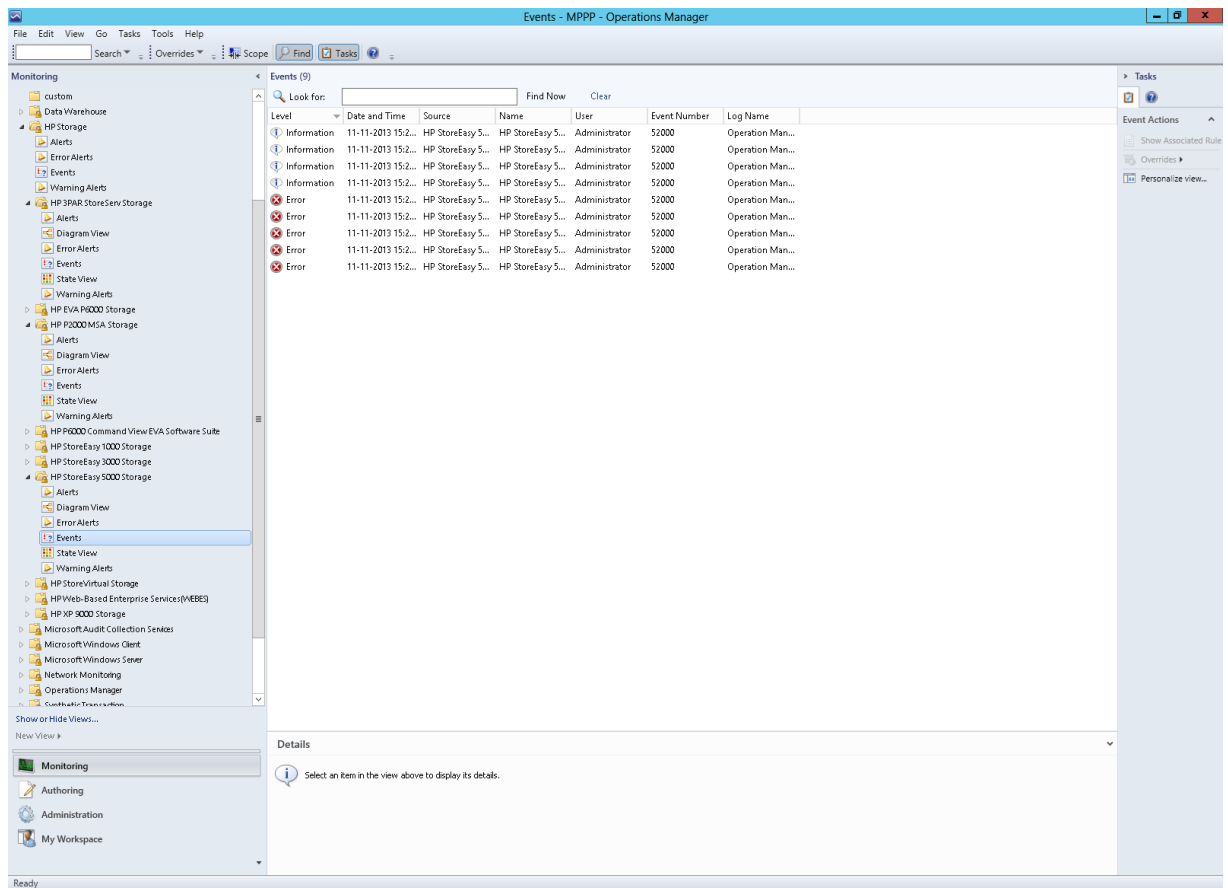

## Diagram View of the HP StoreEasy 5000 Storage

Diagram View displays the diagrammatic representation of the HP StoreEasy 5000 Storage. It displays the information in a four level hierarchy as follows:

1. The first level displays the HP StoreEasy 5000 Storage group. All the HP StoreEasy 5000 Storage discovered will be displayed under this group.
2. The second level displays the HP StoreEasy 5000 Storage with Solution Serial Number.
3. The third level displays the names of the blade servers associated with the StoreEasy 5000.

If any one of the blade server is not working, it is not displayed in the Diagram View. If both the blade servers are not working, the StoreEasy 5000 Storage group in the first level is displayed.

The third level also displays the SAS I/O Modules group and internal disk enclosure name.

4. The fourth level displays the respective SAS I/O modules connected to StoreEasy 5000 storage.

Perform the following steps to see the Diagram View of the HP StoreEasy 5000 Storage:

1. Discover the HP StoreEasy 5000 Storage using the HP Storage Management Pack User Configuration Tool. For more information, see [“Discovery of HP Storage devices using HP Storage Management Pack User Configuration Tool”](#) (page 44).
2. Click **Authoring** pane after you discover the HP StoreEasy 5000 Storage. It displays the Authoring Console.
3. Select **Object Discoveries** and type HP StoreEasy 5000 in the **Look For:** textbox, and click **Find Now**.

The **HP StoreEasy 5000 Storage Discovery Rule** is displayed.

4. Right-click on **HP StoreEasy 5000 Storage Discovery Rule** and select **Override**→**Override the Object Discovery**→**For specific objects of the class: Windows Computer**.

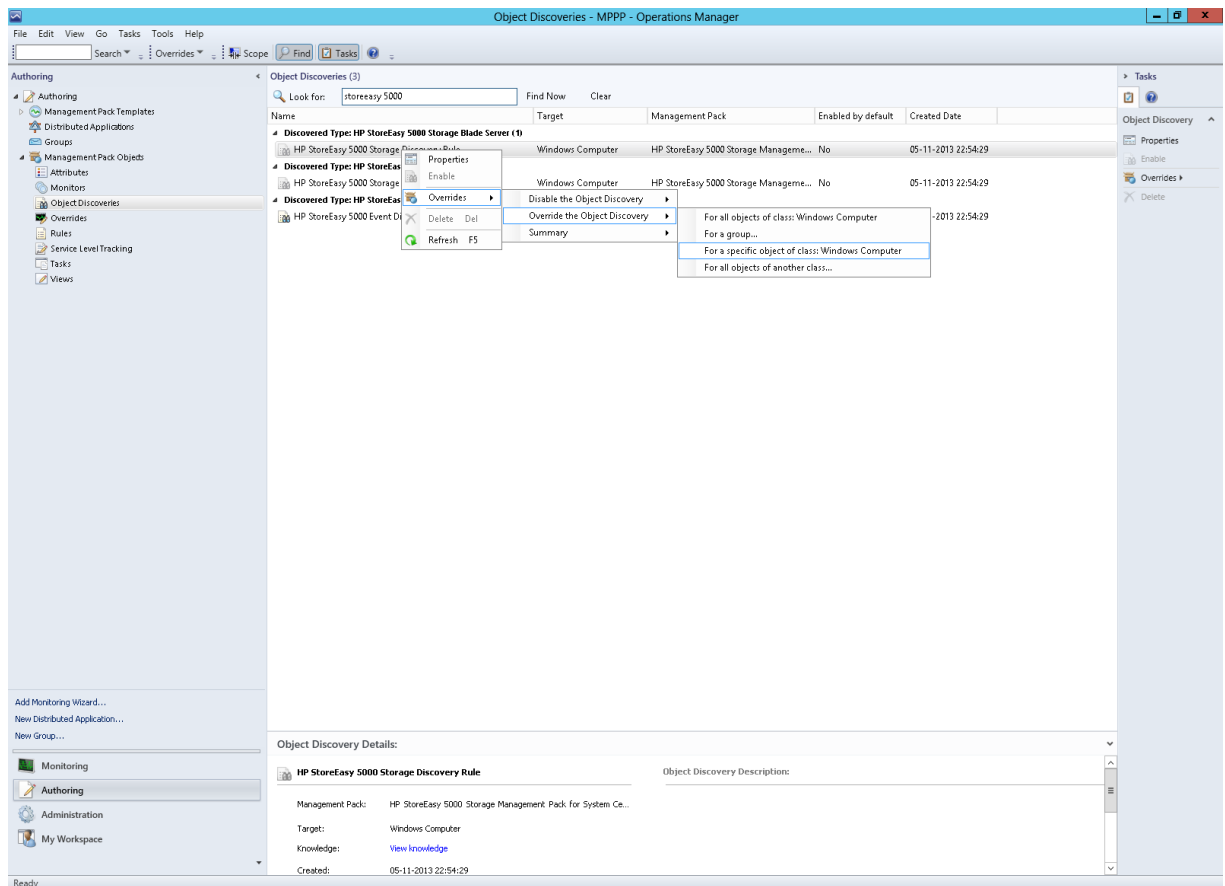

**NOTE:** Enabling one discovery rule for a device will automatically enable the other discovery rule.

5. Select the object where the HP StoreEasy 5000 Storage is discovered using HP Storage Management Pack User Configuration Tool and click **OK**.
6. Select **Enable** checkbox and set the Override Value to **True**.

**NOTE:** By default, the Override value is set to 300 seconds, where the rule takes 300 seconds to apply. Also, the Diagram View will refresh in every 300 seconds. You can specify a minimum of 150 seconds or a maximum of 300 seconds as the override value.

For example, if you change the override value to 150 seconds, then the rule will take 150 seconds to apply and the Diagram View will refresh in every 150 seconds. In case you change the Override Value, navigate to the last option, select the destination Management Pack on the page and click New. Type a name for the management pack and click **Save**.

7. Click **OK**.
8. Click **Monitoring** pane to display the Monitoring console.
9. Click **Diagram View** in the **HP StoreEasy 5000 Storage** folder. The Diagram view of HP StoreEasy 5000 is displayed.

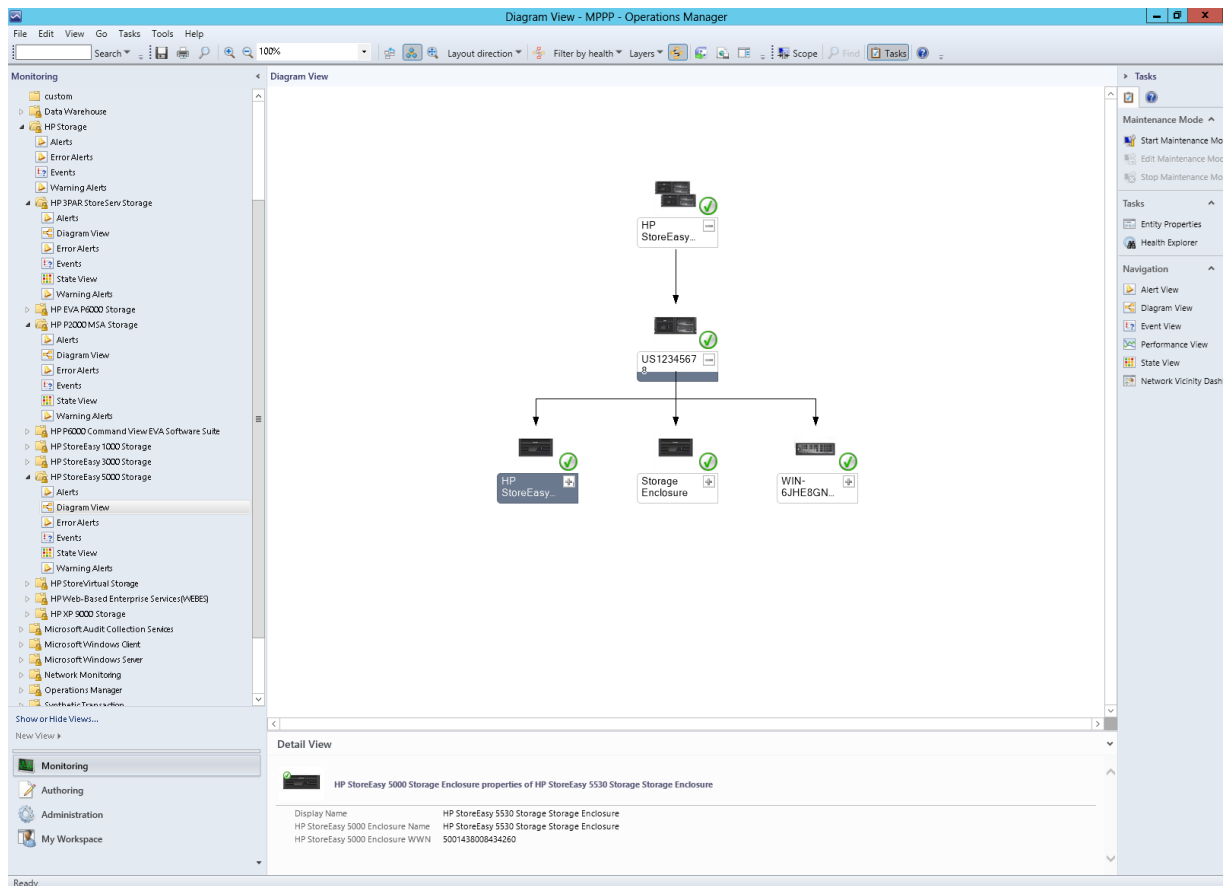

## Configuring the Management Pack for HP StoreEasy 1000 and HP StoreEasy 3000 Storage

### Processing Events/Alerts for HP StoreEasy 1000 and HP StoreEasy 3000 Storage

**NOTE:** Follow the “Discovery of HP StoreEasy 1000 and HP StoreEasy 3000 Storage” (page 103) section to configure the StoreEasy 1000 and StoreEasy 3000 to receive the events in OpsMgr.

Once the HP StoreEasy 1000 and HP StoreEasy 3000 Storage Management Pack is imported into OpsMgr to receive WMI events from the StoreEasy 1000 and HP StoreEasy 3000 Storage device, perform the following steps:

1. Launch the OpsMgr console.
2. Click the **Authoring** pane to display the Authoring console. In the Authoring console, click **Object Discoveries**.
3. Search for **HP StoreEasy 1000 and 3000 Event Discovery Rule** using the **Look for:** search bar in the Rules window.
4. Right-click the **HP StoreEasy 1000 and 3000 Event Discovery Rule** and select **Overrides**→**Override the Rule**.
5. Select **For a specific object of the class: Windows Computer**.
6. Override the rule for a particular HP StoreEasy 1000 or HP StoreEasy 3000. The rule is activated at the OpsMgr server, and WMI events are received.
7. Select the override property after selecting the HP StoreEasy 1000 or HP StoreEasy 3000 server, and change the override setting from **False** to **True**. Click **Ok** to save it to the Default Management Pack.

**NOTE:** It is recommended to save the override settings to the Custom Management Pack instead of the Default Management Pack.

Follow the steps to save the override setting in the Custom Management Pack:

- Click **New** in the **Override Properties** dialog box.
- Enter the name of custom management pack in the text-box, click **Next** and select **Create**.  
This avoids the need to create dependency between Default Management Pack and HP StoreEasy 1000 and 3000 Management Pack for System Center.
- Click **Monitoring** pane to display the Events and Alerts

8. Click **Events** in the **HP StoreEasy 1000 and 3000 Storage** folder. The Events and Alerts of the HP StoreEasy 1000 and 3000 events are displayed.

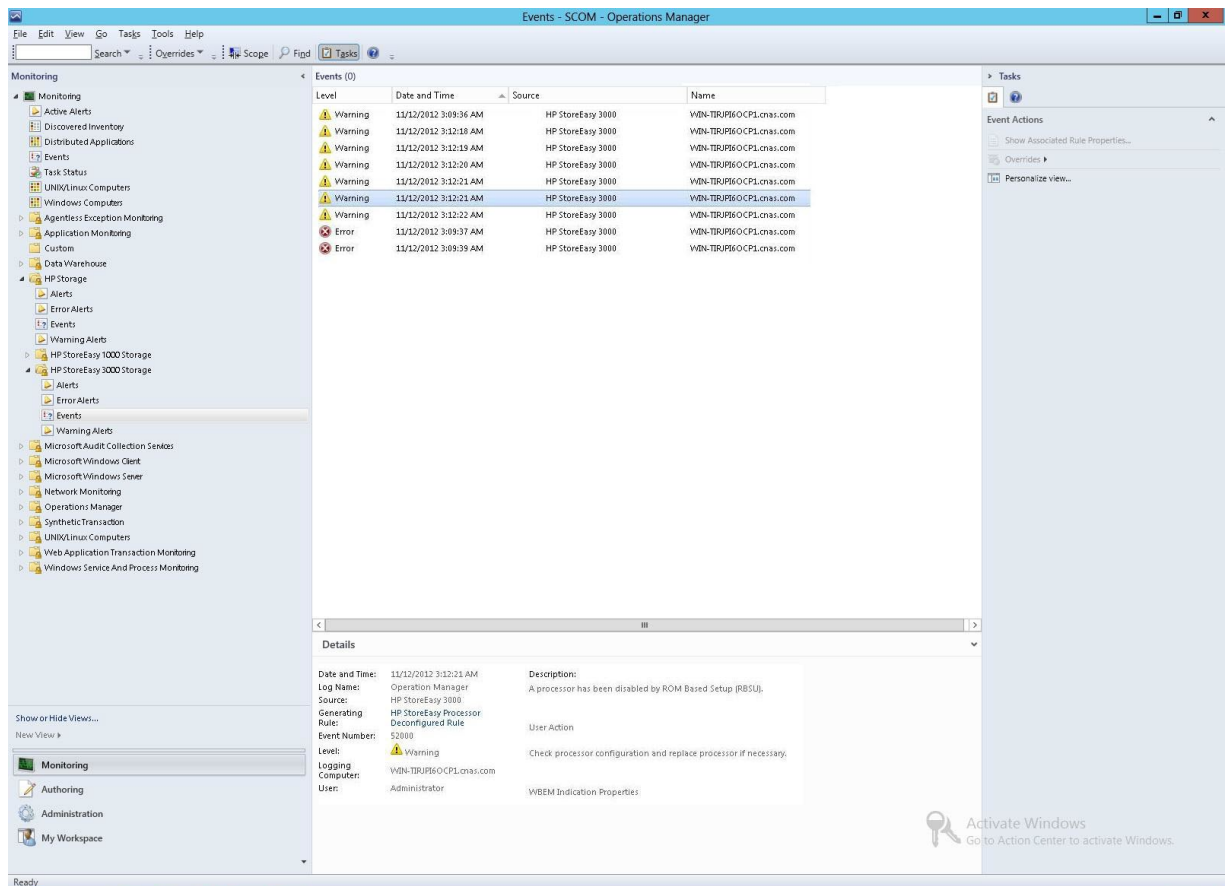

## Configuring the Management Pack for HP XP 9000 Storage

### Processing Events/Alerts for HP XP 9000 Storage

**NOTE:** Follow the steps mentioned in “Getting SNMP traps from HP XP 9000” (page 90) to register the OpsMgr to the SNMP agent of the HP XP 9000 Storage.

Once the HP XP 9000 Storage Management Pack is imported into OpsMgr to receive traps from the XP 9000 Storage, perform the following steps:

1. Launch the OpsMgr console.
2. Click the **Authoring** pane to display the Authoring console. In the Authoring console, click **Object Discoveries**.

3. Search for **HP XP 9000 SNMP Trap Catcher Rule** using the **Look for:** search bar in the Rules window.
4. Right-click the **HP XP 9000 SNMP Trap Catcher Rule** and select **Overrides**→**Override the Rule**.
5. Override the rule for a particular OpsMgr Server Computer Object (list that includes all OpsMgr servers as members), The rule is activated at the OpsMgr server, and SNMP traps are received.
6. Select the override property after selecting the object, and change the override setting from **False** to **True**. Click **Ok** to save it to the Default Management Pack.

**NOTE:** It is recommended to save the override settings to the Custom Management Pack instead of the Default Management Pack.

Follow the steps to save the override setting in the Custom Management Pack:

- Click **New** in the **Override Properties** dialog box.
- Enter the name of custom management pack in the text-box, click **Next** and select **Create**. This avoids the need to create dependency between Default Management Pack and HP XP 9000 Storage Management Pack for System Center.

7. Click **Monitoring** pane to display the Events and Alerts.
8. Click **Events** in the **HP XP 9000 Storage** folder. The Events and Alerts of the HP XP 9000 are displayed.

The screenshot displays the 'Events - MPP - Operations Manager' window. The left-hand navigation pane shows the 'Monitoring' tree with 'HP XP 9000 Storage' expanded to 'Events'. The main pane shows a table of 7 events. The selected event is an 'Error' event from 'HP XP 9000' at '11-11-2013 16:02:38'. The 'Details' pane below shows the following information:

Property Name	Property Value
Date and Time	11-11-2013 16:02:38
Log Name	Operations Manager
Source	HP XP 9000
Generating Rule	HP XP 9000 Raid UserSerious Trap Catcher Rule
Event Number	52000
Level	Error
Logging Computer	NAVSCOMMP27.testdomain.com
User	Administrator

The 'Event Data' section shows a list of properties and their values for the selected event, including EventSource, CLASS, Agent Address, EventTrapREFFCODE, EventTrapDescription, eventTrapPersonalNumber, EventTrapNickname, EventTrapPartsID, EventTrapDate, EventTrapTime, and EventLevel.

# Configuring the Management Pack for HP EVA P6000

## Processing Events/Alerts for HP EVA P6000 Storage

To monitor EVA P6000 events/alerts, ensure that the WEBESListener service is installed. Follow the steps in “[Installing WEBES Listener on WEBES collection point systems](#)” (page 34) section to install the WEBES Listener on WEBES collection point systems.

Once the HP EVA P6000 Storage Management Pack is imported and the WEBESListener service is installed, the EVA P6000 alerts/events are monitored.

To check the events/alerts generated from the EVA P6000 storage follow the steps below:

1. Launch the OpsMgr console.
2. Click **Monitoring** pane to display the Events and Alerts.
3. Click **Events** in the **HP EVA P6000 Storage** folder. The Events and Alerts of the HP EVA P6000 are displayed.

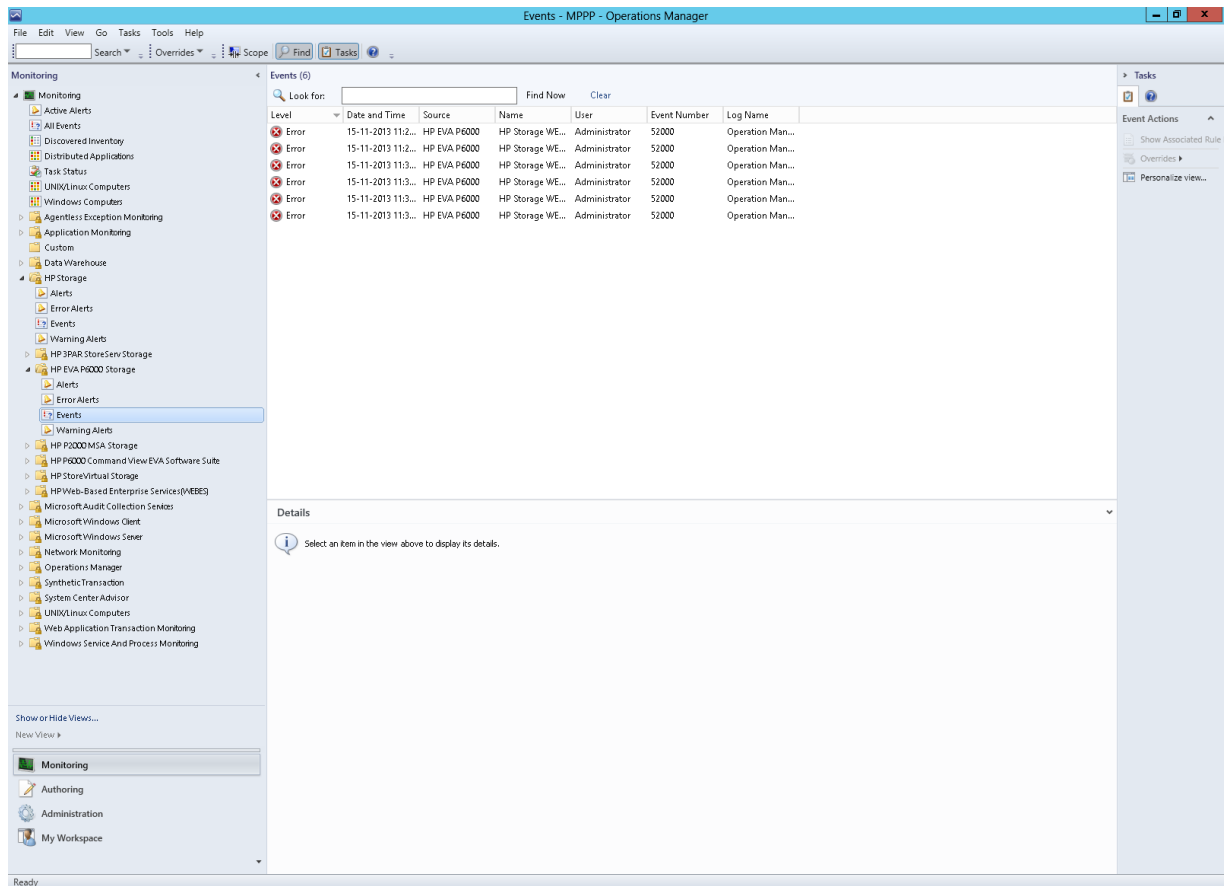

# Configuring the Management Pack for HP StoreOnce Backup

## Processing Events/Alerts for HP StoreOnce Backup

**NOTE:** Follow the steps mentioned in “[Getting SNMP traps from HP StoreOnce Backup](#)” (page 89) to register the OpsMgr to the SNMP agent of the HP StoreOnce Backup.

Once the HP StoreOnce Backup Management Pack is imported into OpsMgr to receive traps from the StoreOnce Backup, perform the following steps:

Perform the following steps to check the events or alerts generated from the StoreOnce Backup:

1. Launch the OpsMgr console.
2. Click the **Authoring** pane to display the Authoring console. In the Authoring console, click **Object Discoveries**.
3. Search for **HP StoreOnce SNMP Trap Catcher Rule** using the **Look for:** search bar in the Rules window.
4. Right-click the **HP StoreOnce SNMP Trap Catcher Rule** and select **Overrides**→**Override the Rule**.
5. Select **For a specific object of the class: Windows Computer**.
6. Override the rule for a particular OpsMgr Server Computer Object (list that includes all OpsMgr servers as members), The rule is activated at the OpsMgr server, and SNMP traps are received.
7. Select the override property after selecting the object, and change the override setting from **False** to **True**. Click **Ok** to save it to the Default Management Pack.

**NOTE:** It is recommended to save the override settings to the Custom Management Pack instead of the Default Management Pack.

Follow the steps to save the override setting in the Custom Management Pack:

- Click **New** in the **Override Properties** dialog box.
- Enter the name of custom management pack in the text-box, click **Next** and select **Create**.

This avoids the need to create dependency between Default Management Pack and HP StoreOnce Backup Management Pack for System Center.

8. Click **Monitoring** pane to display the Events and Alerts.
9. Click **Events** in the **HP StoreOnce Backup** folder. The Events and Alerts of the HP StoreOnce Backup are displayed.

The screenshot shows the Microsoft Operations Manager (OpsMgr) console. The main window is titled "Events - MPP - Operations Manager". The left-hand pane shows the "Monitoring" tree with the "HP StoreOnce Backup" folder expanded, and the "Events" sub-folder selected. The main pane displays a list of events with columns for Level, Date and Time, Source, Name, User, Event Number, and Log Name. The events are sorted by date and time, showing a series of warnings and errors from 12-11-2013 12:10:37 to 12-11-2013 12:10:37. The details pane below the list shows the following information:

Property Name	Value
CLASS	SNMP_SEMI_MIB_hpHttpMgDeviceAddedTrap_Notification
AgentAddress	15.218.170.32
DeviceIndex	8
DeviceManagementURL	http://16.181.49.172:4095
DeviceManagementURLLabel	ESL E-SeriesESL712EU550341043 Device Added
DeviceSysObjID	1.3.6.1.4.1.11.103.1.3.27
TIME_CREATED	130387120240255891
EventLevel	4

# Configuring the Management Pack for HP E5000 Messaging System

## Processing Events/Alerts for HP E5000 Messaging System

---

**NOTE:** Follow the “Discovery of HP E5000 Messaging System” (page 95) section to configure the E5000 Messaging System to receive the events in OpsMgr.

To receive events and alerts through WMI for E5000 Messaging System, configure the E5000 Messaging System Management Pack to process the WMI events and alerts. This option is disabled by default and requires manual creation of an Override Rule in the OpsMgr.

By default, the following two rules are disabled for E5000 Messaging System:

- HP E5000 Chassis Event Catcher Rule
  - HP E5000 Cascade Event Catcher Rule
- 

Select only one blade server from E5000 Messaging System to avoid duplicate events.

Once the HP E5000 Messaging System Management Pack is imported into OpsMgr to receive WMI events from the E5000 system, perform the following steps:

1. Launch the OpsMgr console.
  2. Click the **Authoring** pane to display the Authoring console. In the Authoring console, click **Rules**.
  3. Do one of the following:
    - Search for **HP E5000 Chassis Event Catcher rule** using the **Look for:** search bar in the Rules window.  
Right-click the **HP E5000 Chassis Event Catcher rule** and select **Overrides**→**Override the Rule**.
    - Search for **HP E5000 Cascade Event Catcher Rule** using the **Look for:** search bar in the Rules window.  
Right-click the **HP E5000 Cascade Event Catcher Rule** and select **Overrides**→**Override the Rule**.
  4. Select **For a specific object of the class: HP E5000 Event Discovery Rule**.
  5. Override the rule for a particular E5000 blade server. The rule is activated at the OpsMgr server, and WMI events are received.
  6. Select the override property after selecting the E5000 blade server, and change the override setting from **False** to **True**. Click **Ok** to save it to the Default Management Pack.
- 

**NOTE:** It is recommended to save the override settings to the Custom Management Pack instead of the Default Management Pack.

Follow the steps to save the override setting in the Custom Management Pack:

- Click **New** in the **Override Properties** dialog box.
  - Enter the name of custom management pack in the text-box, click **Next** and select **Create**.
- 

This avoids the need to create dependency between Default Management Pack and HP E5000 Messaging System Management Pack for System Center.

7. Click **Monitoring** pane to display the Events and Alerts.
8. Click **Events** in the **HP E5000 Messaging System** folder. The Events and Alerts of the HP E5000 Messaging System events are displayed.



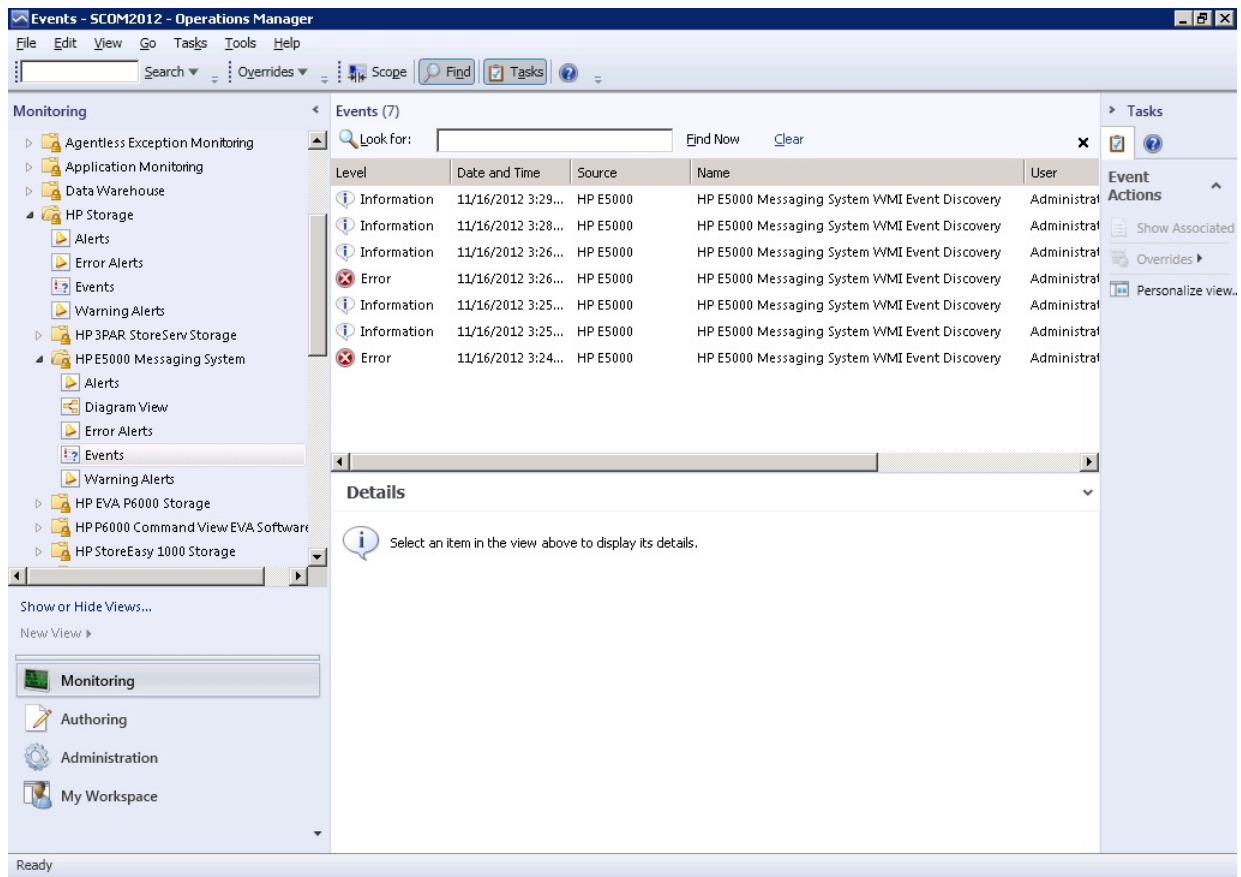

## Diagram View of the HP E5000 Messaging System

Diagram View displays the diagrammatic representation of the HP E5000 Messaging System. It displays the information in a four level hierarchy as follows:

1. The first level displays the E5000 Messaging System group. All the E5000 Messaging System in the domain will be displayed under this group.
2. The second level displays the E5000 Messaging System with Solution Serial Number.
3. The third level displays the chassis component of the E5000 Messaging System. The chassis name is also displayed.
4. The fourth level displays the names of the blade servers associated with the E5000 Messaging System.

If any one of the blade server is not working, it is not displayed in the Diagram View. If both the blade servers are not working, the E5000 Messaging System group in the first level is displayed.

Perform the following steps to see the Diagram View of the HP E5000 Messaging System:

1. Discover the HP E5000 Messaging System using the HP Storage Management Pack User Configuration Tool. For more information, see [“Discovery of HP Storage devices using HP Storage Management Pack User Configuration Tool”](#) (page 44).
2. Click the **Authoring** pane after discovering the HP E5000 Messaging System. It displays the Authoring Console.
3. Select **Object Discoveries** and type HP E5000 System in the **Look For:** textbox.
4. Right-click the **HP E5000 System Discovery Rule** and select **Override**→**Override the Object Discovery**→**For specific objects of the class: Windows Computer**.

Select the object where the HP E5000 System is discovered using HP Storage Management Pack User Configuration Tool and click **OK**.

**NOTE:** Enabling one discovery rule for a device will automatically enable the other discovery rule.

5. Select Enable checkbox and set the Override Value to **True**.

**NOTE:** By default, the Override value is set to 300 seconds, where the rule takes 300 seconds to apply. Also, the Diagram View will refresh in every 300 seconds. You can specify a minimum of 150 seconds or a maximum of 300 seconds as the override value.

For example, if you change the override value to 150 seconds, then the rule will take 150 seconds to apply and the Diagram View will refresh in every 150 seconds. In case you change the Override Value, navigate to the last option, select the destination Management Pack on the page and click **New**. Type a name for the management pack and click **Save**.

6. Click **OK**.
7. Click **Monitoring** pane to display the Monitoring console.
8. Click **Diagram View** in the **HP E5000 Messaging System** folder. The Diagram view of the HP E5000 System is displayed.

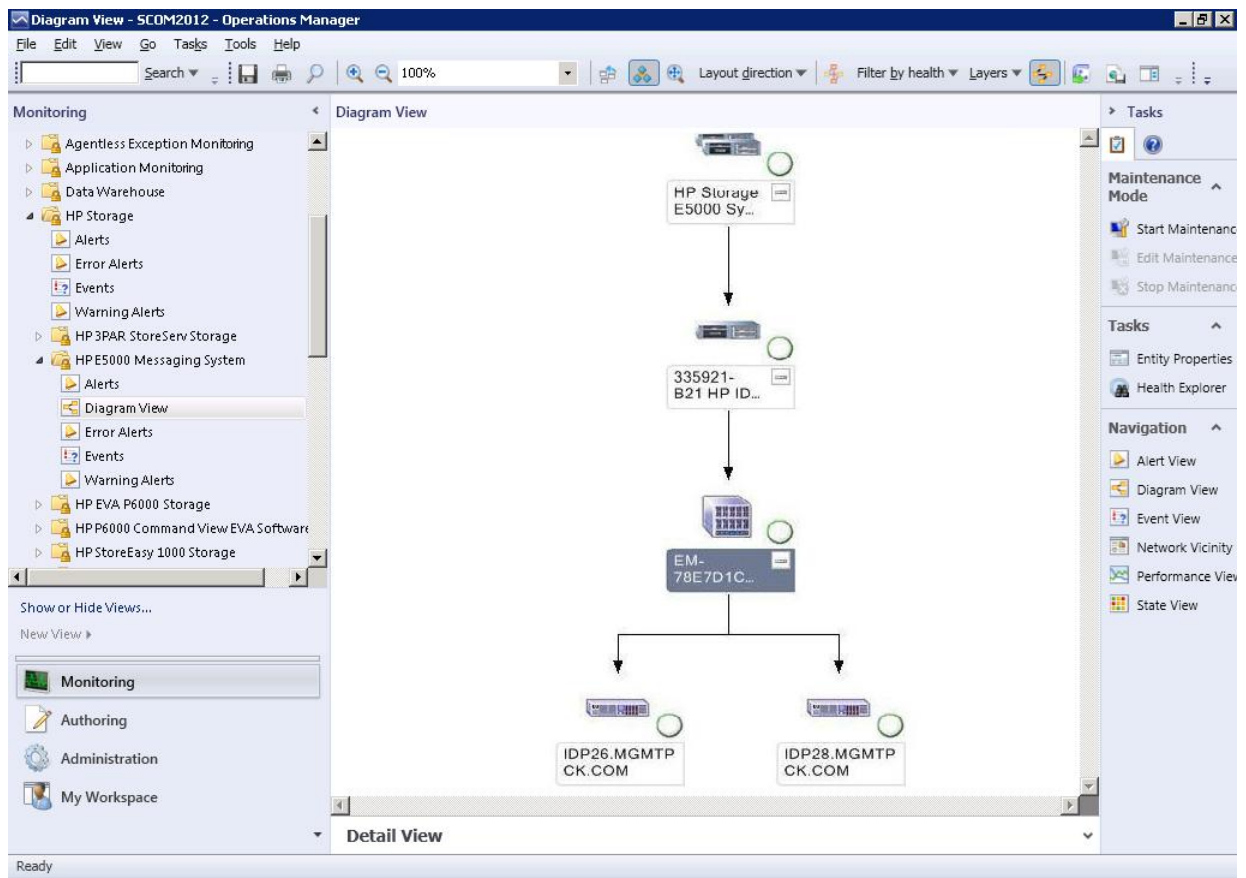

## Configuring the Management Pack for HP StoreEver Tape Libraries

### Processing Events/Alerts for HP StoreEver Tape Libraries

Follow the steps mentioned in [“Getting SNMP traps from HP StoreEver Tape Libraries”](#) (page 90) to register the OpsMgr to the SNMP agent of the HP StoreEver Tape Libraries.

Once the HP StoreEver Tape Libraries Management Pack is imported into OpsMgr to receive traps from the StoreEver Tape Libraries, perform the following steps:

1. Launch the OpsMgr console.
2. Click **Authoring** pane to display the Authoring console. In the Authoring console, click **Object Discoveries**.
3. Search for **HP StoreEver Tape Libraries SNMP Trap Catcher Rule** using the **Look for:** search bar in the Rules window.
4. Right-click the **HP StoreEver Tape Libraries SNMP Trap Catcher Rule** and select **Overrides**→**Override the Rule**.
5. Select **For a specific object of the class: Windows Computer**.
6. Override the rule for a particular OpsMgr Server Computer Object (list that includes all OpsMgr servers as members), The rule is activated at the OpsMgr server, and SNMP traps are received.
7. Select the override property after selecting the object, and change the override setting from **False** to **True**. Click **Ok** to save it to the Default Management Pack.

**NOTE:** It is recommended to save the override settings to the Custom Management Pack instead of the Default Management Pack.

Follow the steps to save the override setting in the Custom Management Pack:

- Click **New** in the **Override Properties** dialog box.
- Enter the name of custom management pack in the text-box, click **Next** and select **Create**. This avoids the need to create dependency between Default Management Pack and HP StoreEver Tape Libraries Management Pack for System Center.

8. Click **Monitoring** pane to display the Events and Alerts.
9. Click **Events** in the **HP StoreEver Tape Libraries** folder. The Events and Alerts of the HP StoreEver Tape Libraries are displayed.

The screenshot displays the Microsoft Operations Manager console. The main pane shows a list of events for the 'HP StoreEver Tape Libraries SNMP Trap Catcher Rule'. The selected event is a 'Warning' event generated on 11/14/2013 at 9:19:52 AM. The details pane below shows the following information:

Property Name	Property Value
Date and Time	11/14/2013 9:19:52 AM
Log Name	Operations Manager
Source	TLM5L6480
Generating Rule	HP StoreEver Tape Warning Trap Catcher Rule
Event Number	52000
Level	Warning
Logging Computer	SCOM2012R2.SCOM.com
User	Administrator
Event Data	<pre> EVENTCODE=0205001-4015-EVENTDESCRIPTRN=Power Supply has failed. Redundancy is not available. POWER_SUPPLY 1.3.6.1.4.1.11.102.1.3.29 130208923150925995 2 </pre>

# 3 Configuration for monitoring device

## SNMP

### Configuration of SNMP service

Complete the following steps to install SNMP on Windows 2012 Server or later:

1. Launch the Server Manager.

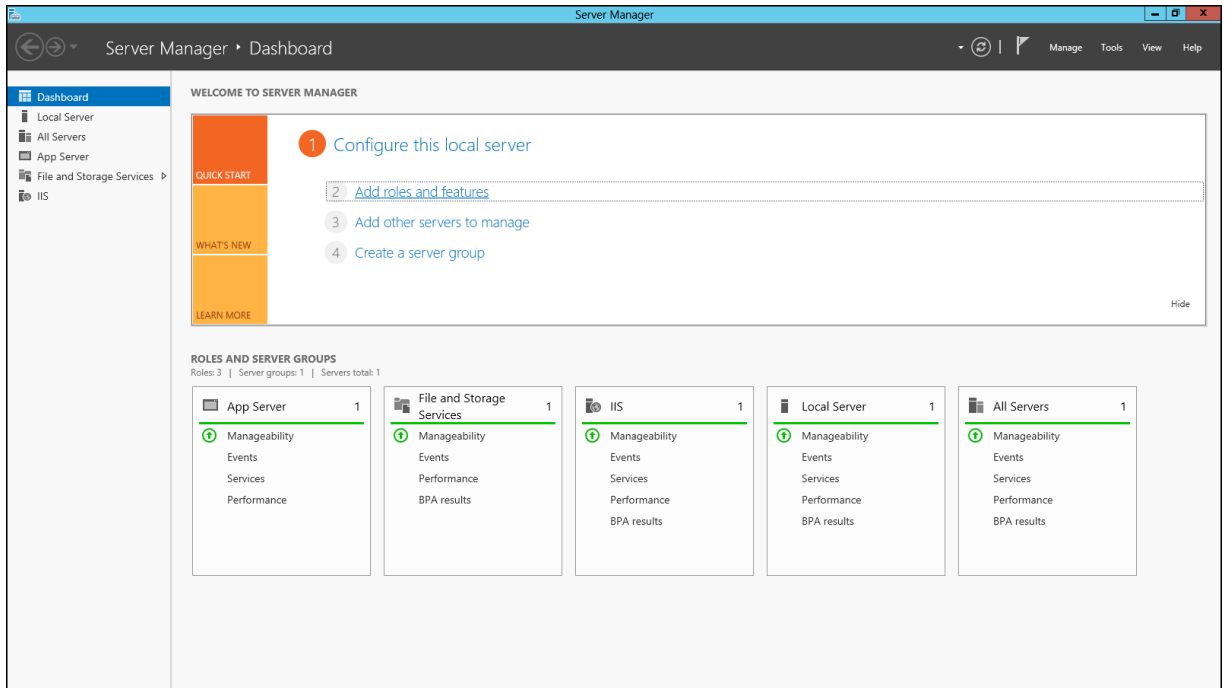

2. Select **Features**.
3. Click **Add Features** from the **Features** pane.
4. Select the SNMP Service and SNMP WMI Provider from the list and click **Next**.
5. Click **Install**.

If your SNMP and OpsMgr Server is installed on the same system, you must install the SNMP Service from Microsoft Windows Control Panel by completing the following steps for Windows Server 2003:

1. Open the Windows **Control Panel**.
2. Double-click **Add/Remove Programs**.
3. Click **Add/Remove Windows Components**.
4. Select the **Management and Monitoring tools** option from the **Windows Components Wizard** window.  
Click **Details**.
5. Select **Simple Network Management Protocol**.
6. Double-click **Administrative Tools > Services**. The SNMP **Services** screen is displayed.

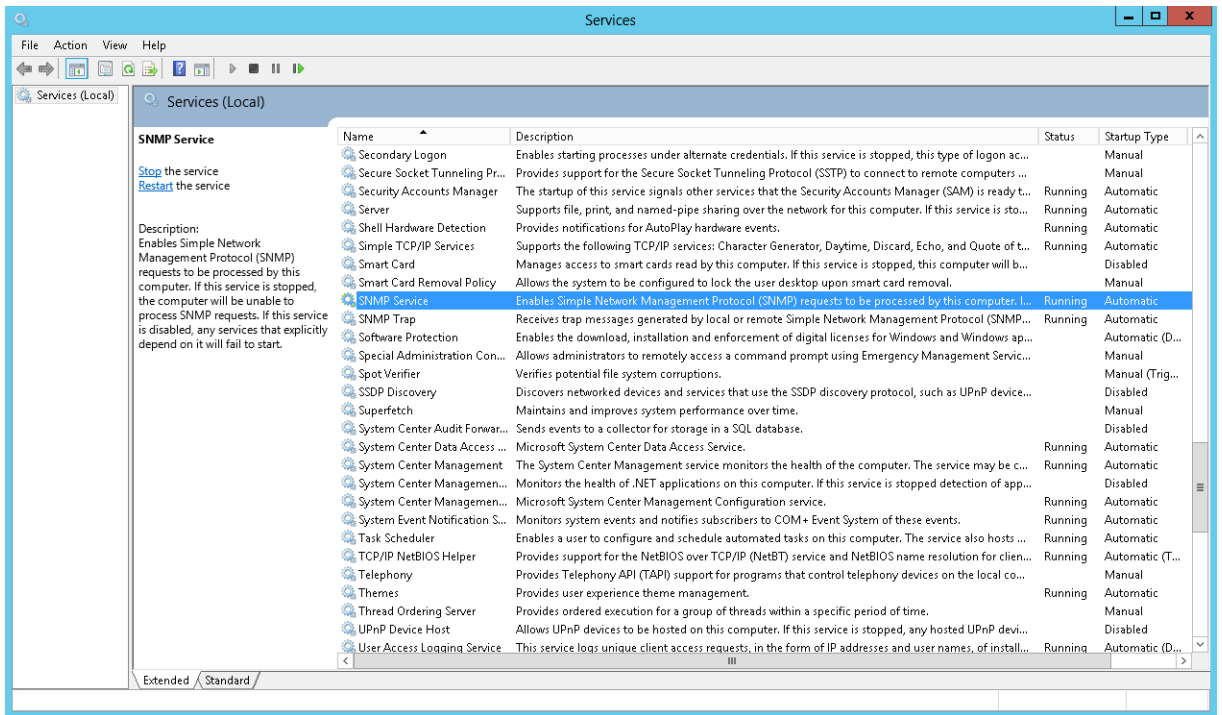

- Right-click **SNMP Service**, and select the **Properties** menu to configure the SNMP service on the OpsMgr server. The **SNMP Service Properties** window is displayed.

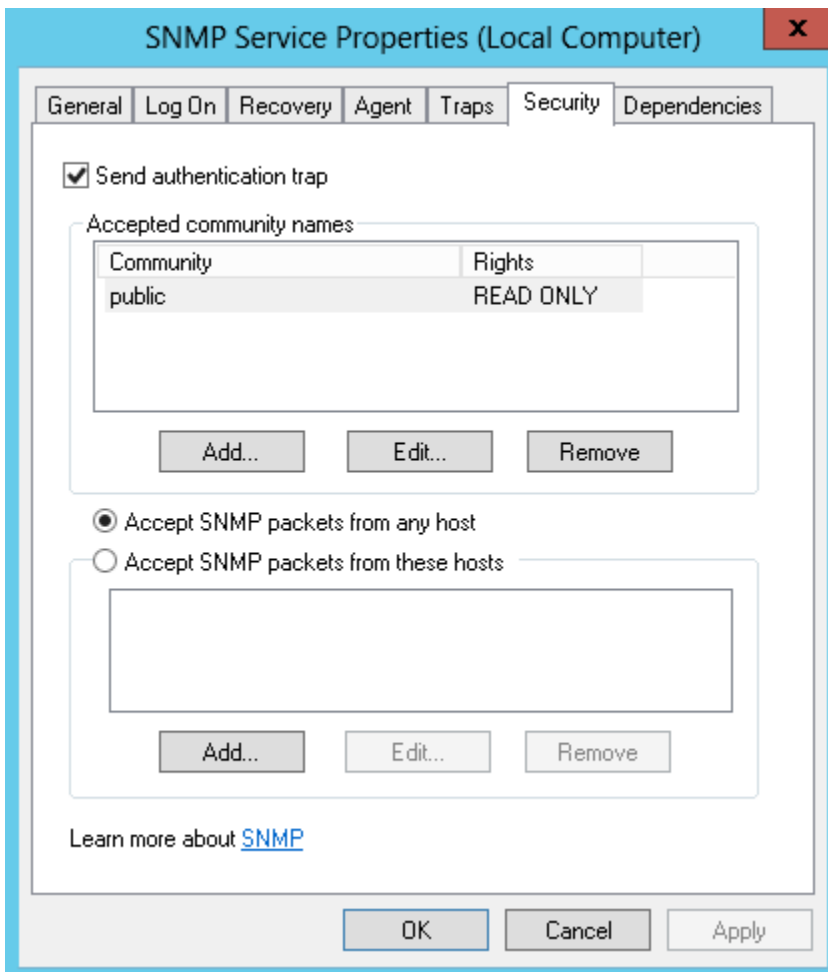

- Click **Security** and select **Accept SNMP Packets from any hosts**.

9. Click **Add**.
10. Enter the HP Command View hosts name you want to monitor, and click **Add**. The **SNMP Service Configuration** dialog box is displayed.

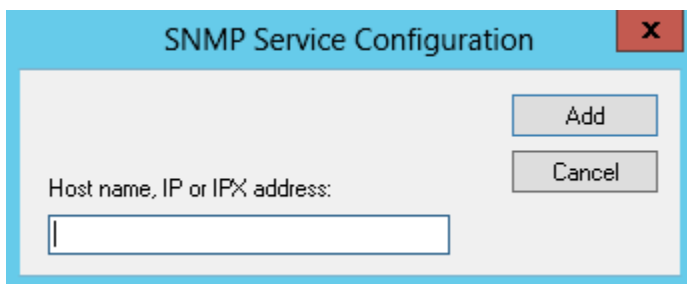

11. Configure the SNMP trap generator on the HP Command View server.
12. Configure the HP Command View storage environment hosts to send the SNMP traps to the OpsMgr server.

## Configuration of OpsMgr Server to process SNMP traps

Enable the SNMP Trap catcher in the HP Storage Management Pack. For information on enabling the SNMP Trap Catcher, see the configuration sections of the respective HP storage devices.

Please traverse to the Windows service control manager and check if the services, "SNMP Service" and "SNMP Trap Service", are installed and started.

Create an Event or Alert view in the OpsMgr console with the target as SNMP Trap Catcher discovery. Send some test traps from the device managed to the OpsMgr station.

Events/Alerts will be displayed in the console under the View created. If Events/Alerts are not displayed under the view, check for any errors in the SNMP trap destination setting. Review the trap destination setting for the HP 3PAR StoreServ Storage, HP StoreVirtual Storage, HP P2000 MSA Storage, HP XP 9000, HP StoreOnce Backup, and HP StoreEver Tape Libraries.

## Getting SNMP Traps from HP 3PAR StoreServ Storage

The SNMP agent of the HP 3PAR StoreServ Storage converts all system alerts and alert state changes into SNMPv2 traps and forwards them to all registered SNMP management stations.

Follow the steps to register the OpsMgr or the collection point to the SNMP agent of the HP 3PAR StoreServ Storage:

1. Login to the HP 3PAR StoreServ Storage array through CLI.
2. Type the `addsnmpmgr` command for setting the trap recipient address.

For example:

```
addsnmpmgr [options <arg>] <manager_IP>
```

- [options <arg>]
  - a. `-p <port_number>`  
Specifies the port number where the SNMP manager receives traps. This option is used if the port number differs from the default of 162.
  - b. `-pw <password>`  
Specifies the SNMP manager's access community string (password), using up to 32 alphanumeric characters. If unspecified, the agents send traps without an access password.
  - c. `-r <retry>`  
Specifies the number of times to send a trap (  
<retry>

) using an integer from 1 through 15 if the SNMP manager is not available. If not specified, the number of times a trap is sent defaults to 2.

d. -t <timeout>

Specifies the number of seconds to wait before sending a trap (

<timeout>

) using an integer from 1 through 300. If not specified, the time defaults to 200 seconds.

- <manager\_IP>

a. Manager\_IP address is the OpsMgr server IP address.

---

**NOTE:** You need access to all domains in order to run this command.

---

After successfully completing these steps, HP 3PAR StoreServ Storage traps will be forwarded to OpsMgr or the collection point.

## Getting SNMP traps from HP StoreVirtual Storage System

SNMP Trap configuration is done using the HP LeftHand Centralized Management Console [CMC]. Configuring SNMP Traps involves the following activities:

- “Enabling an SNMP agent” (page 87)
- “Adding an SNMP client” (page 87)
- “Enabling SNMP traps” (page 88)

For more information on configuring SNMP traps, see the HP StoreVirtual SAN User Manual.

### Enabling an SNMP agent

To enable an SNMP agent, complete the following steps:

1. Log in to the storage node and expand the tree.
2. Select the **SNMP** category from the tree.
3. On the **SNMP General** tab window, click **SNMP General Tasks** and select **Edit SNMP Settings**.
4. Select the **Enabled** radio button to activate the SNMP Agent fields.
5. Enter the **Community String**.
6. [Optional] Enter **System Location** information for the storage node.

For example, this information may include the address, building name, room number, and so on.

7. [Optional] Enter **System Contact** information.

Normally this will be network administrator information such as email address, or phone number for the person you would contact if you could not connect to SNMP clients.

### Adding an SNMP client

In the **Access Control** section, click **Add** to add an SNMP client. This SNMP client can be used to view SNMP.

You can add SNMP clients by specifying either IP addresses or host names in the following manner:

- By IP address:
  1. Select “**By Address**” and type the IP address.
  2. Select an IP Netmask from the list. Select **Single Host** if adding only one SNMP client.

3. Click **OK**. The IP address and netmask entry appear in the **Access Control** list.
  4. Click **OK** in the **Edit SNMP Settings** window to finish.
- By host name:
    1. Select "**By Name**" and type a host name. That host name must exist in DNS and the NSM must be configured with DNS for the client to be recognized by the host name.
    2. Click **OK**.  
The host name appears in the **Access Control** list.
    3. Click **OK** in the **Edit SNMP Settings** window to finish.

## Enabling SNMP traps

You must add a Trap Community String for client-side authentication. To add a Trap Community String complete the following steps:

1. Log in to the storage node and expand the tree.
2. Select the **SNMP** category from the tree.
3. Select the **SNMP Traps** tab.
4. Click **SNMP Trap Tasks** and select **Edit SNMP Traps**.
5. Click **Add** to add trap recipients.
6. Enter the IP address or hostname for the SNMP client receiving the traps.
7. Click **OK**.
8. Repeat Step 5 through Step 7 for each host in the trap community.
9. Click **OK** on the **Edit SNMP Traps** window when you are finished adding hosts.

## Getting SNMP traps from HP P2000 MSA Storage

### Monitoring SNMP traps for MSA 1000 and 1500 series arrays

To monitor MSA 1000 and 1500 series arrays using SNMP traps and OpsMgr, complete the following steps:

1. Browse to the System Management Home Page of the HP P2000 MSA management server where HP Insight Management Agents have been installed.
2. Click on the **Settings** Tab.
3. Click on **Trap** to add the trap destination.
4. Add the IP and community string settings of the OpsMgr server.
5. Click **Apply**.

After successfully completing these steps the HP P2000 MSA traps will be forwarded to OpsMgr server or to the collection point.

### Monitoring SNMP traps for P2000 series arrays

To monitor P2000 series arrays using SNMP traps and OpsMgr, perform the following steps:

1. Login to the P2000 array's CLI using SSH.  
For more information about this process, see the P2000 user documentation. 50 Configuration for monitoring device.
2. Set up and enable SNMP trap destination by running the command as following: `set snmp-parameters [enable crit|warn|info|none] [add-trap-hostaddress] [ del-trap-host adress][read-community string] [write-community string]`.

**Table 8 SNMP parameters and its functions**

Parameter	Description
<code>enable crit error warn info none</code>	Optional. Sets the level of the trap notification:



**Table 8 SNMP parameters and its functions** *(continued)*

Parameter	Description
	crit: Sends notifications for Critical events only. error: Sends notifications for Error and Critical events. warn : Sends notifications for Warning, Error, and Critical events. info: Sends notifications for all events. none: All events are excluded from trap notification and traps are disabled.
add-trap-host <address>	Optional. Specifies the IP address of a destination host that will receive traps. Three trap hosts can be set.
del-trap-host <address>	Optional. Deletes a trap destination host.
read-community <string>	Sets an alpha numeric community string for Read-only access
Write-community <string>	Sets an alpha numeric community string for writ-only access
trap-host-list <trap-host-list>	Optional. Replaces the current list.

**Example:**

```
set snmp-parameters enable crit add-trap-host 172.22.4.171  
Success: SNMP parameters changed.
```

## Getting SNMP traps from HP StoreOnce Backup

SNMP Trap configuration is done using the Interface Manager which supports SNMP traps/alerts. Configuring SNMP Traps involves the following common SNMP settings:

**Trap Destinations:** IP addresses of hosts or applications that need to receive SNMP alerts/traps from the Interface Manager. A trap receiver is an SNMP-enabled machine on the LAN that decodes and logs SNMP traps.

### Adding an SNMP trap destination

To add a new SNMP trap, enter:

1. If necessary, obtain the required network settings from your network administrator.
2. In the StoreOnce GUI window, click **Configuration** tab.
3. Select the **SNMP** tab.
4. In the destinations section, click **Add** button.
5. Enter the Trap Destination IP and Description, and click **Update**.

### Editing an SNMP trap destination

To edit an existing trap destination entry:

1. In the StoreOnce GUI window, click **Configuration** tab.
2. Select the **SNMP** tab.
3. In the destinations section, select the trap destination IP that needs to be modified and click the **Edit** button.
4. Modify and click the **Update** button.

### Removing an SNMP trap destination

To remove an existing trap destination entry:

1. In the StoreOnce GUI window, click **Configuration** tab.
2. Select the **SNMP** tab.

3. In the destinations section, select the trap destination IP that needs to be removed and click the **Remove** button.

## Getting SNMP traps from HP XP 9000

To configure XP 9000 devices, complete the following steps:

1. Open <http://docs.hp.com>
2. Click Storage Solutions and then select Disk Storage Systems.  
The list of XP 9000 array models are displayed.
3. Select the appropriate XP 9000 array model.
4. Download the respective User Guide and use it to configure the respective XP 9000 array.

### Example:

For HP Storage XP24000 Disk Array, click on HP Storage XP24000 Disk Array and download the SNMP Agent Reference Guide. Use the same to configure the XP 24000 array.

## Getting SNMP traps from HP StoreEver Tape Libraries

SNMP Trap configuration is done using the Interface Manager card which has a built-in SNMP agent that supports queries to MIB-II in addition to SNMP traps/alerts. Configuring SNMP Traps involves the following common **SNMP** settings:

1. **Trap Destinations:** IP addresses of hosts or applications that need to receive SNMP alerts/traps from the Interface Manager card. A trap receiver is an SNMP-enabled machine on the LAN that decodes and logs SNMP traps. Up to eight trap destinations can be specified.
2. Plain-text community string or password required by SNMP clients to read or write SNMP MIB values.

## Adding an SNMP trap

To add a new SNMP trap entry:

1. If necessary, obtain the required network settings from your network administrator.
2. In the Library window, click **Configuration** tab.
3. In the left panel, select **SNMP Alerts**.  
The current SNMP traps appear in the right panel.
4. Do one of the following:  
In the right panel, right-click an SNMP trap, and select Add Trap Entry.  
Select Actions > Add Trap Entry.  
The SNMP Trap Entry dialog box appears.
5. Enter the Trap Destination and Community String, and click **OK**.

## Editing an SNMP trap

To edit an existing trap entry:

1. In the Library window, click **Configuration** tab.
2. In the left panel, select **SNMP Alerts**.  
The current SNMP traps appear in the right panel.
3. Do one of the following:
  - In the right panel, double-click a **trap** entry.
  - In the right panel, right-click a **trap** entry, and then select **Edit Trap** Entry.
  - In the right panel, select the **trap** entry to be modified, and then select **Actions > Edit Trap Entry**.

The SNMP Trap Entry dialog box appears.

4. Modify the Trap Destination and Community String as necessary, and click **OK**.

## Removing an SNMP trap

To remove an existing trap entry:

1. In the Library window, click **Configuration** tab.
2. In the left panel, click **SNMP Alerts**.

The current SNMP traps appear in the right panel.

3. Do one of the following:
  - In the right panel, right-click the **trap** entry that you want to remove, and then select **Remove Trap Entry**.
  - In the right panel, select the **trap** entry that you want to remove, and then select **Actions > Remove Trap Entry**.
4. Confirm that you want to delete the **SNMP** trap.

## WEBES Events

### Monitoring WEBES

When WEBES monitors a EVA P6000, it analyzes the EVA P6000 event flow and issues notification messages when required. Typically, the messages are sent to a Local Administrator Group responsible for the operational status of the EVA P6000. WEBES can also send information to several supported management applications, such as the HP Systems Insight Manager (HP SIM).

### Generating WEBES test event

To generate WEBES test events on a system running WEBES, complete the following steps:

1. Verify that an evt file named similar to `eva_events.evt` is located in:
  - `~\Program Files\HP\svctools\common\ca\examples` directory for a 32-bit operating system
  - `~\Program Files (x86)\HP\svctools\common\ca\examples` directory for a 64-bit operating system
2. Enter the following test command for a 32-bit operating system :

```
~\Program Files\HP\svctools\common\bin> wsea n analyze input <Path of eva_events.evt  
>\eva_events.evt not vis
```

Or enter the following test command on 64-bit operating system:

```
~\Program Files (x86)\HP\svctools\common\bin>wsea n analyze input <Path of eva_events.evt  
>\eva_events.evt not vis
```

This will generate several test events, depending on the version of WEBES you are using.

---

**NOTE:** If the test messages do not appear on the OpsMgr console, then in the system where WEBES listener service is installed, look for `WEBESListenerLog.log` file in the `~\Program Files\HP\ HP Storage WEBES Listener for System Center` for a 32-bit operating system, and `~\Program Files (x86)\HP\ HP Storage WEBES Listener for System Center` for a 64-bit operating system. To verify the communication path from the WEBES through the WEBES Listener to the OpsMgr in your environment, see [Configuring WEBES to send an XML event callout](#)

---

### Viewing events using Windows

To view events in Microsoft Windows, complete the following steps:

1. Do one of the following:

- For a 32-bit operating system:

Go to **Start + Programs + Administrative Tools + Event Viewer**, and find **WEBESEventListener**.

- For a 64-bit operating system:

Go to **Start + All Programs + Administrative Tools + Event Viewer**, and find **WEBESEventListener**.

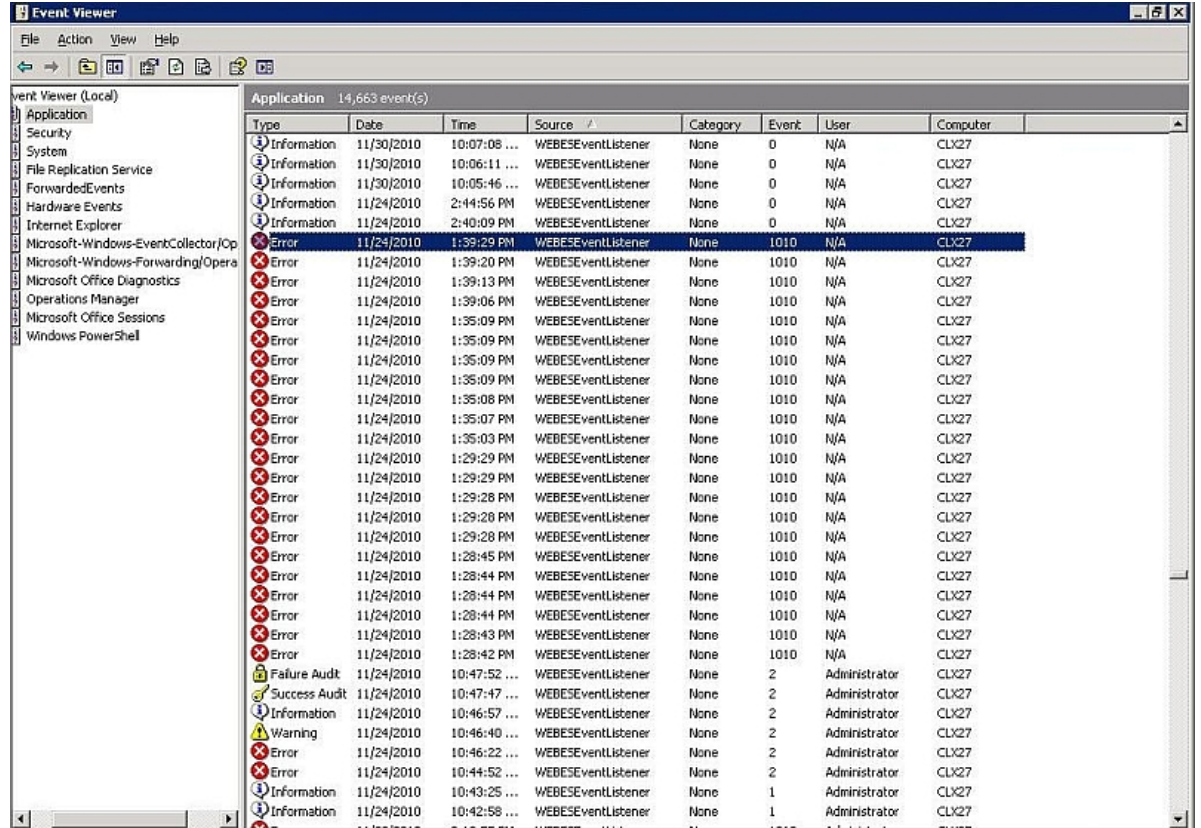

2. Double-click **WEBESEventListener**. The Event Properties window is displayed.

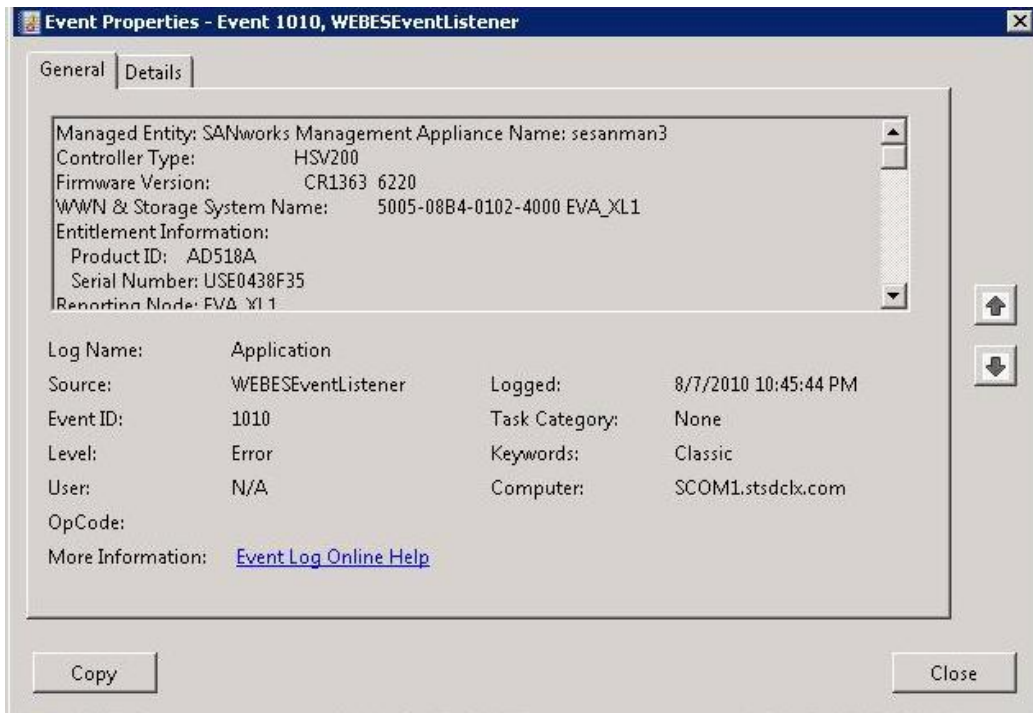

## Interpreting WEBES messages

WEBES Messages enable you to do the following:

- Triggers an event on any component failure and sends it to HP, if linked to ISEE.
- EVA P6000 event flow allows distinction between component failure and component removal for most of its components. For example, the physical removal of a disk drive or power supply is significantly different from a drive or power supply failure.
- Looks for patterns, combinations, and variations in the event stream. It analyzes the event stream and looks at the context of each event within the stream. Conditions around a specific event in the event stream can significantly change the context of that event. WEBES may indicate normal expected behavior in one case and a clear component failure in another.
- Displays a Consequence message prior to the actual failure or environmental message. This is because of time-out conditions, but this must not occur frequently or with excessive time differences.
- Reports a component failure once during a predetermined time period (usually 24 hours, unless a successful repair is detected). When a failed drive is replaced, it is considered a new component (even if inserted in the same location), because it has a different unique identifier. As a result, there is no silence period for the replaced drives.

---

**NOTE:** Informational, Environmental and Consequence messages can be distinguished from Failure messages by the letters CUST: in the short description of the message.

---

Table 9 (page 94) lists the categories of WEBES messages.

**Table 9 WEBES Messages**

Messages	Description
Informational messages	These messages occur as part of normal behavior of the EVA P6000, such as when a cloning operation completes, when a controller successfully boots, and so on.
Suggested response	No immediate action is needed, but you may need to monitor some processes when these status changes occur.
Environmental messages	These messages are triggered by abnormal situations outside the control of EVA P6000. This includes when a disk group becomes low on free space, when a temperature sensor approaches critical, when AC input power fails, when the cache battery power is low, when a controller host port goes offline, when changes in the CA status occur when a component is removed, and so on.
Suggested response	The local EVA P6000 administrator group must take appropriate actions in response to these messages, because they can affect the operational status of the EVA P6000, if left unresolved. The EVA P6000 hardware is not the cause of these messages; the issue is elsewhere in the environment.
Simple Failure message	These messages identify a EVA P6000 component which has either failed, become degraded, or is otherwise exhibiting abnormal behavior and must be replaced. These messages can occur when a disk drive exceeds error thresholds, becomes degraded or fails, when a power supply fails, when a blower assembly becomes degraded, and so on.
Suggested response	If WEBES is linked to ISEE, RSS, or RSA, this message is sent directly to HP to arrange component replacement. The Local Administrator Group receives a copy of this message. If WEBES is not linked to ISEE, RSS, or RSA, the administrator must contact HP for assistance. All failure messages are linked to the HP Customer Self Repair program.
Complex Failure messages	These messages occur when WEBES detects an abnormality in the EVA P6000, which may be caused by a hardware failure or firmware issue, and the cause of the failure cannot be immediately identified. These messages may occur when a server-side Fibre Channel loop fails, when a controller does an abnormal termination, and so on.
Suggested response	If WEBES is linked to ISEE, RSS, or RSA, this message is sent directly to HP for further diagnosis. In this situation, a HP support engineer needs to investigate the EVA P6000 logs to determine the root cause and replace any defective components. If the EVA P6000 Event log collection is enabled (WEBES 6.1, 6.2, and 6.3), then WEBES also mails these logs directly to HP, avoiding a call-back delay to collect them (details follow on next page). The Local Administrator Group receives a copy of this message. If WEBES is not linked to ISEE, RSS, or RSA, the administrator must contact HP for assistance.
Consequence messages	These messages report EVA P6000 state changes as a consequence of a Simple Failure, a Complex Failure, or an Environmental message. These messages can occur when a virtual disk goes offline, when a disk group becomes degraded, and so on.
Suggested response	The Local Administrator Group receives these messages as informational messages, to scope the impact of the failure

**Table 9 WEBES Messages** (continued)

Messages	Description
	on their operational environment. Even if WEBES is linked to ISEE, RSS, or RSA, these messages are not sent to HP if the message is a consequence of the Simple or Complex Failure message. Information from the Simple or Complex Failure is sent to HP, instead.

## WMI events

### Understanding HP E5000 Messaging System/HP StoreEasy 5000 Storage System configuration

The E5000 Messaging System/HP StoreEasy 5000 Storage System providers log event information into WMI namespaces. These WMI indications are used for monitoring the E5000 System/HP StoreEasy 5000 Storage System. HP Storage Management Pack rules have a built-in feature to listen to the WMI indications from the E5000/HP StoreEasy 5000 Storage chassis and storage providers. It generates appropriate events on the OpsMgr console.

**NOTE:** The HP Storage Management Pack supports events only from the chassis and storage components of E5000 Messaging System and HP StoreEasy 5000 Storage System.

For more information on how to monitor events from blade servers in an E5000 Messaging System, see the E5000 Messaging System product documentation.

For more information on how to monitor events from blade servers in an HP StoreEasy 5000 Storage System, see the HP StoreEasy 5000 Storage System product documentation.

### Discovery of HP E5000 Messaging System

To monitor E5000 Messaging Systems remotely, the OpsMgr needs to discover the E5000 Systems. OpsMgr provides discovery options to list the available servers in the domain to be managed. Ensure that the E5000 blade server and the OpsMgr server are part of the same domain.

**NOTE:** The E5000 Messaging System has to be directly managed by management server with help of OpsMgr Agent installed on the managed device during the discovery process.

To discover E5000 Systems in the domain of the management server, complete the following steps:

## 1. Run the **Discovery Wizard**.

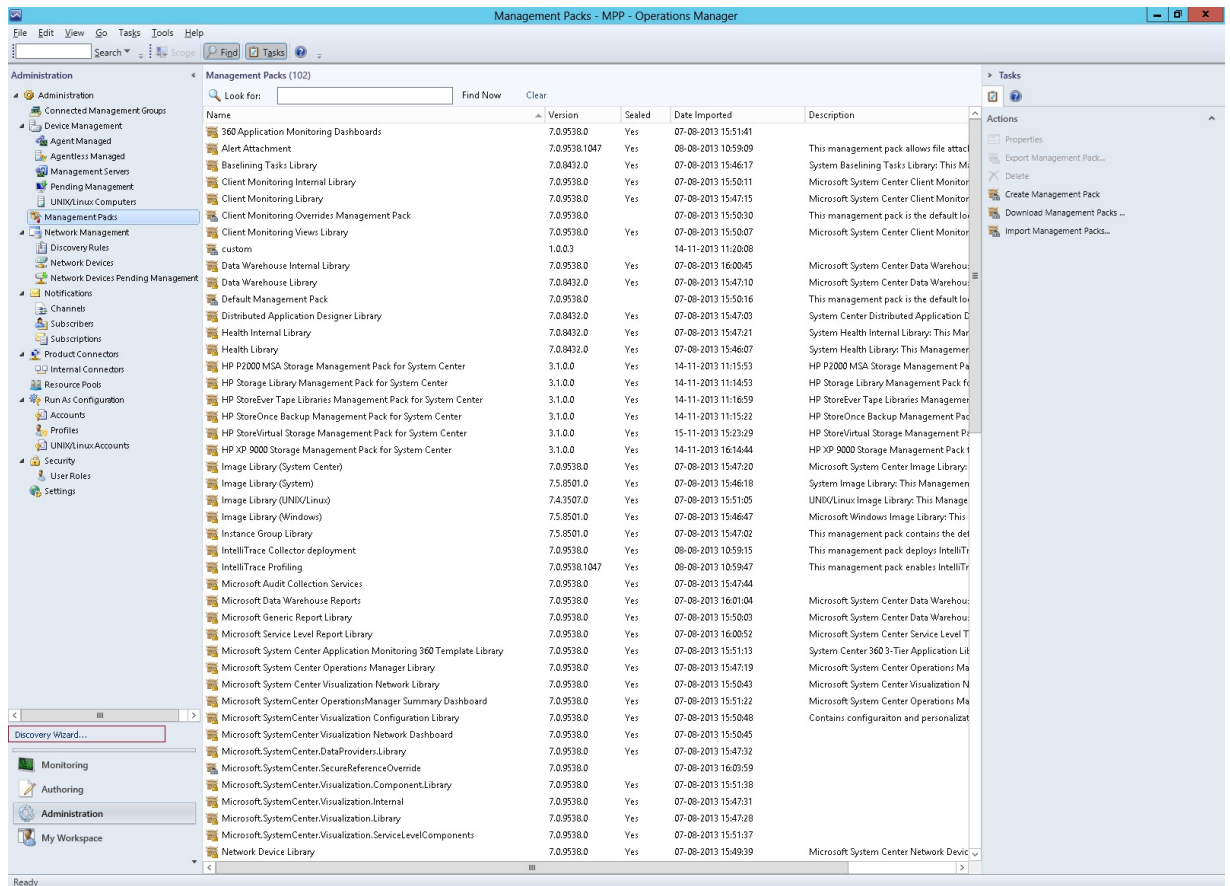

## 2. The **Computer and Device Management Wizard** appears. Select **Windows Computers** and click **Next**.



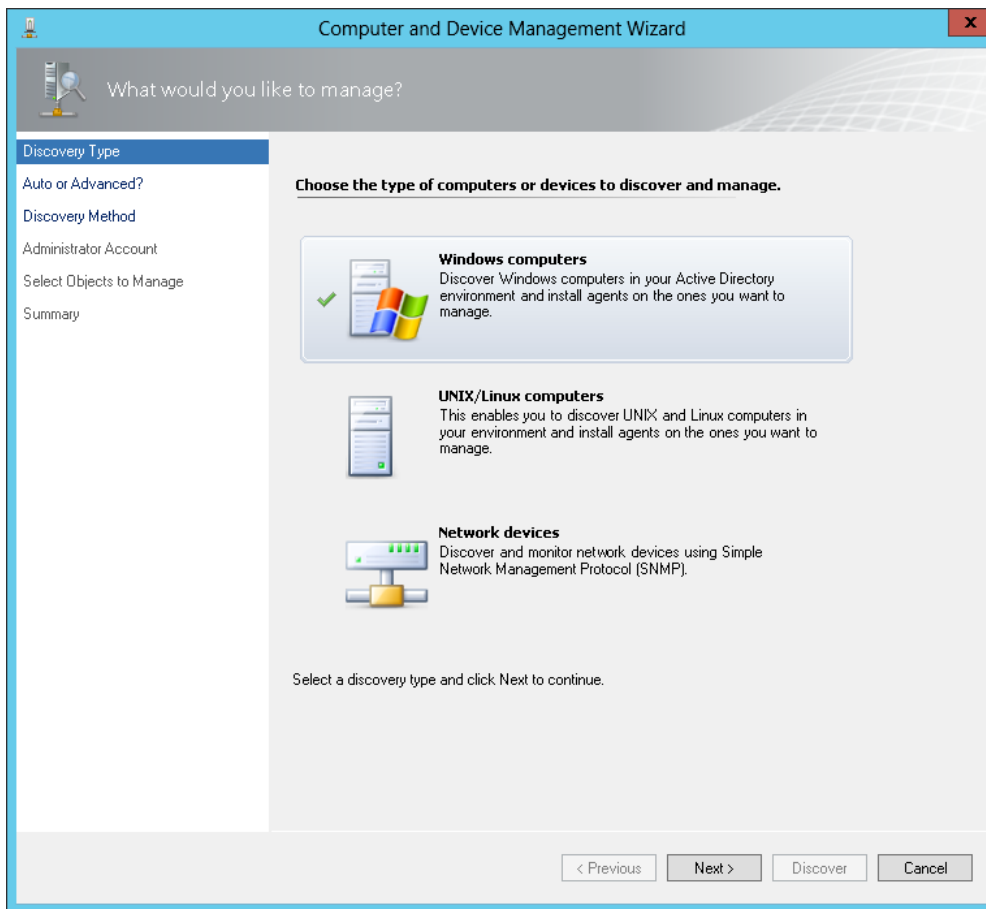

3. Select **Automatic Computer Discovery** and click **Next**.

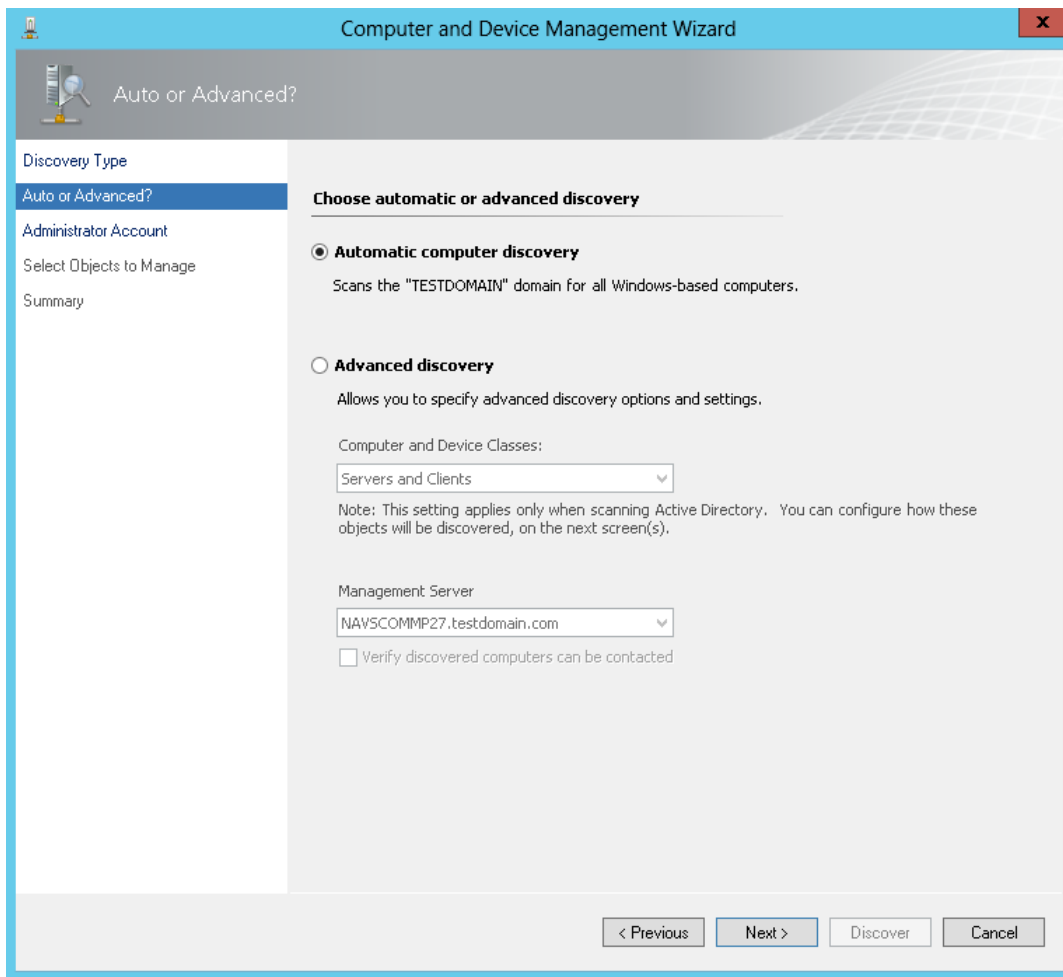

4. Select the **Other user account** with the domain of the E5000 blade server and the OpsMgr server.

Enter the **User name** and **Password**. Click **Discover**.

---

**NOTE:** Ensure that you have the administrative privileges to login.

---

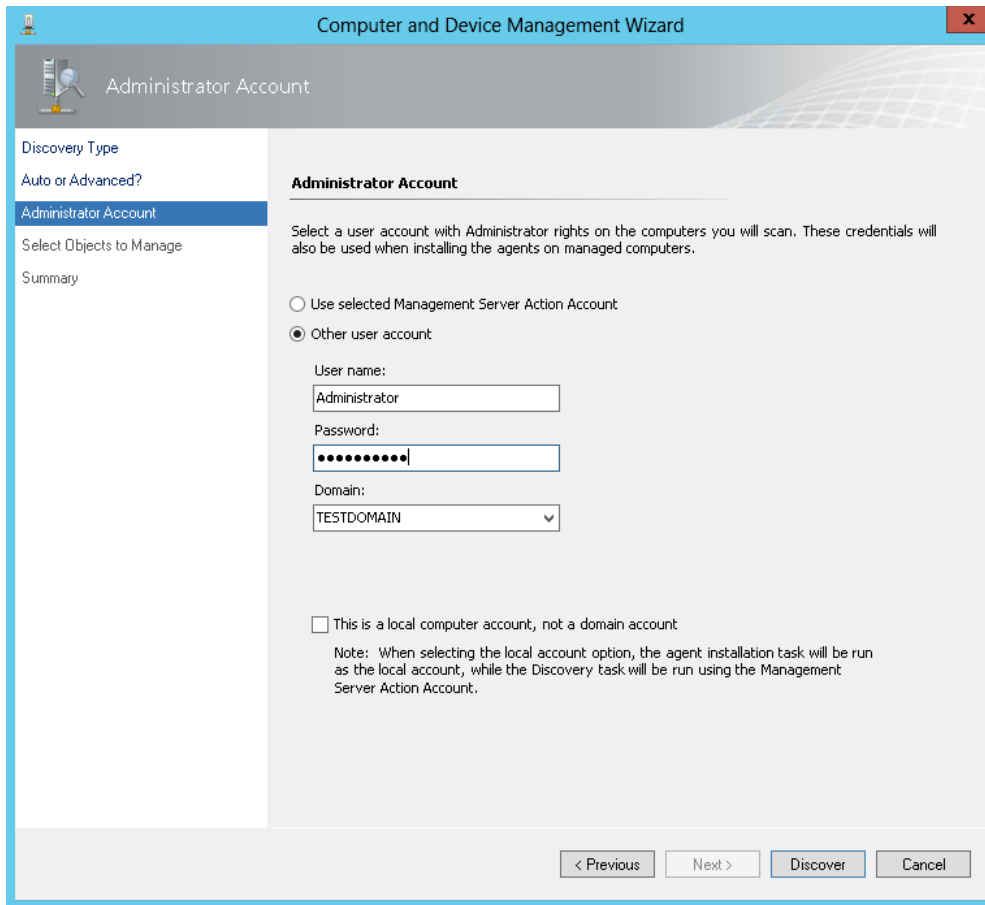

5. The Discovery starts finding the computers or the network devices in the network.

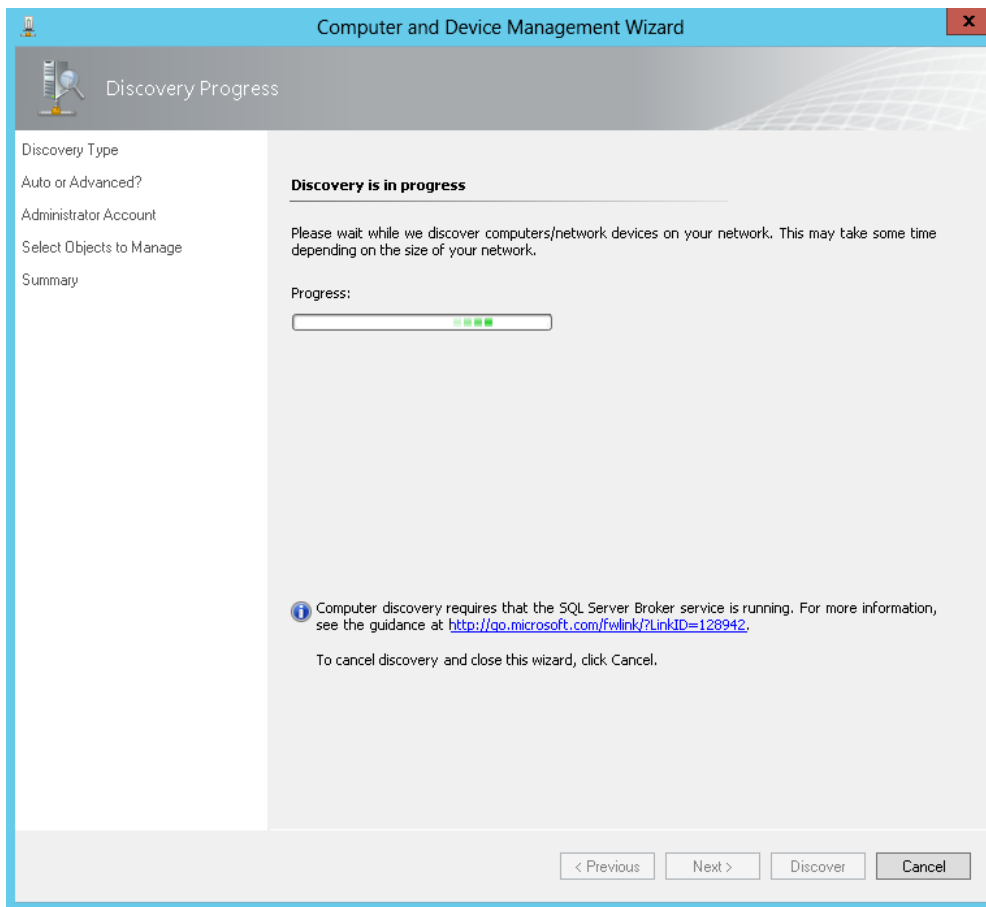

6. The **Computer and Device Management Wizard** displays the search results. Select the discovered **E5000 blade server** that you want to monitor, and select **Agent** in the **Management Mode** list box. Click **Next**.

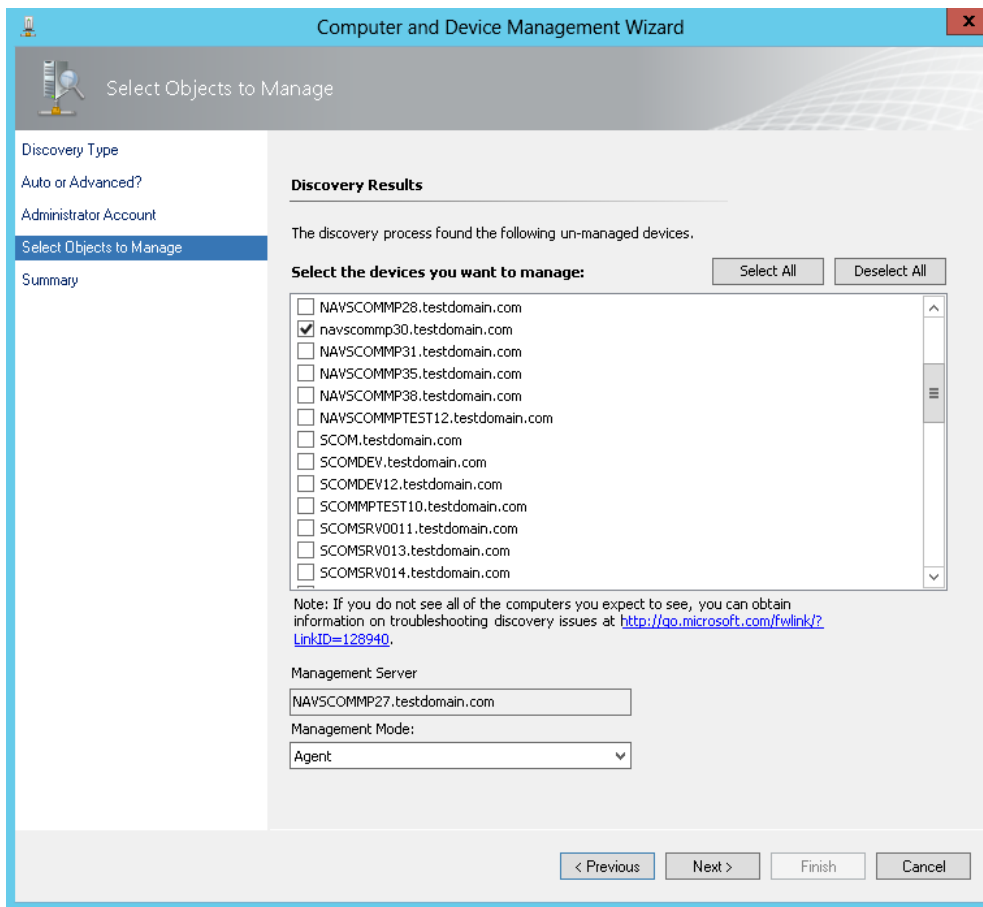

7. Enter the **User name**, **Password**, and select the appropriate **Domain**. Click **Finish**.

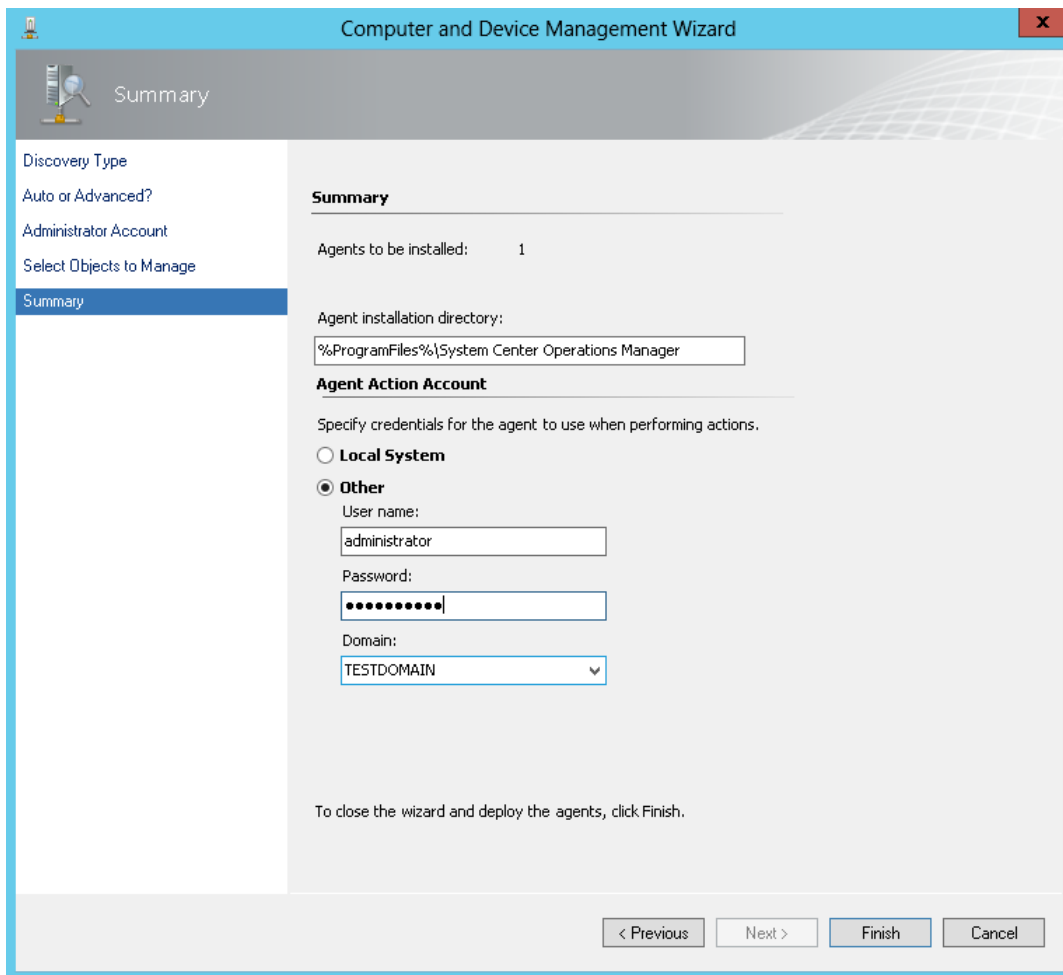

8. The OpsMgr Agent will start installing on the selected computer.

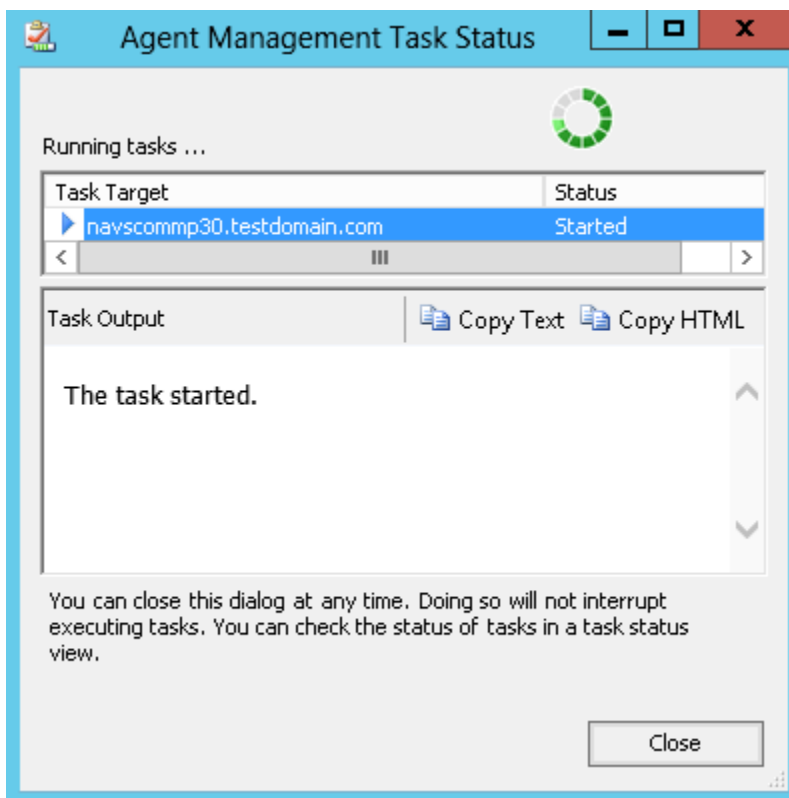

9. After the successful installation of the OpsMgr Agent, a message **The task completed successfully** is displayed.

---

**NOTE:** If the Agent Installation fails, see the OpsMgr product documentation.

---

## Discovery of HP StoreEasy 5000 Storage

To monitor HP StoreEasy 5000 Storage Systems remotely, the OpsMgr needs to discover the HP StoreEasy 5000 Storage Systems. OpsMgr provides discovery options to list the available servers in the domain to be managed. Ensure that the HP StoreEasy 5000 Storage blade server and the OpsMgr server are part of the same domain.

---

**NOTE:** The HP StoreEasy 5000 Storage System has to be directly managed by management server with help of OpsMgr Agent installed on the managed device during the discovery process.

---

To discover HP StoreEasy 5000 Storage Systems in the domain of the management server, follow the procedure described in “Discovery of HP E5000 Messaging System” (page 95).

## Getting WMI Events from HP E5000 Messaging System/HP StoreEasy 5000 Storage

To view the events from the E5000 Messaging System/StoreEasy 5000 Storage on OpsMgr console, configuration changes are not required on the E5000 System/StoreEasy 5000 Storage. Ensure that WMI service is running and WBEM providers are installed on the E5000 System/StoreEasy 5000 Storage. For more information on the E5000 Messaging System and the list of supported events, see <http://www.hp.com/go/E5000>

For more information on the StoreEasy 5000 Storage and the list of supported events, see <http://www8.hp.com/us/en/products/file-object-storage/index.html>

---

**NOTE:** The HP Storage Management Pack supports events only from the chassis and storage components of E5000 Messaging System or StoreEasy 5000 Storage. For more information on how to monitor events from blade servers in an E5000 Messaging System, see the E5000 Messaging System product documentation. For more information on how to monitor events from blade servers in an StoreEasy 5000 Storage, see the StoreEasy 5000 Storage product documentation.

---

## Discovery of HP StoreEasy 1000 and HP StoreEasy 3000 Storage

To monitor StoreEasy 1000 and StoreEasy 3000 Storage remotely, the OpsMgr needs to discover the StoreEasy 1000 and StoreEasy 3000 . OpsMgr provides discovery options to list the available servers in the domain to be managed. Ensure that the StoreEasy 1000 and StoreEasy 3000 storage and the OpsMgr server are part of the same domain.

---

**NOTE:** The StoreEasy 1000 and StoreEasy 3000 Storage has to be directly managed by management server with help of OpsMgr Agent installed on the managed device during the discovery process.

To discover StoreEasy 1000 and StoreEasy 3000 Storage in the domain of the management server, follow the procedure described in “Discovery of HP E5000 Messaging System” (page 95).

---

## Discovery of HP 3PAR StoreServ File Controller

To monitor the HP 3PAR StoreServ File Controller remotely, discover the HP 3PAR StoreServ File Controller in the OpsMgr .

---

**NOTE:** Ensure the following:

- HP 3PAR StoreServ File Controller and the OpsMgr server are on the same domain
- Ensure HP 3PAR StoreServ File Controller System is managed by the OpsMgr Agent installed on the managed device during the discovery process.

To discover HP 3PAR StoreServ File Controller in the domain of the management server, follow the procedure described in “[Discovery of HP E5000 Messaging System](#)” (page 95).

---

## Getting WMI Events from HP 3PAR StoreServ File Controller

To view HP 3PAR StoreServ File Controller events on OpsMgr console, ensure that the WMI service is running. For more information on the HP 3PAR StoreServ File Controller see <http://www8.hp.com/us/en/products/file-object-storage/product-detail.html?oid=6608649#!tab=specs>.



# 4 Using the Management Pack software

## View Discovered Inventory

After the HP Storage Management Pack is imported, on running the discovery wizard the discovered computers get classified into various HP Storage Computer Groups. Complete the following steps to view discovered HP Storage Computer Groups:

1. Click the **Monitoring** pane.
2. Click **Discovered Inventory**.

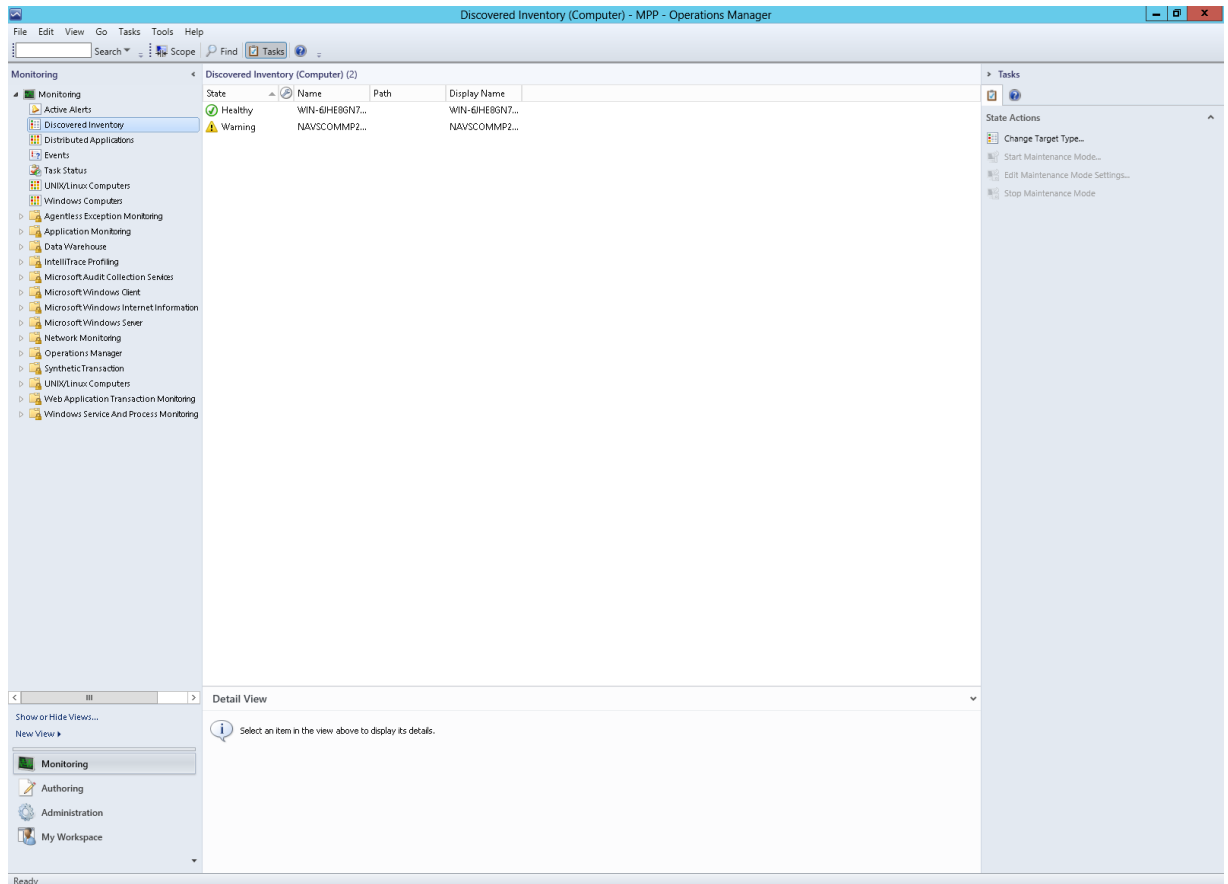

3. Click **Actions** from the toolbar. The Actions console appears. Click the **Change Target Type** option from the **Actions** console.

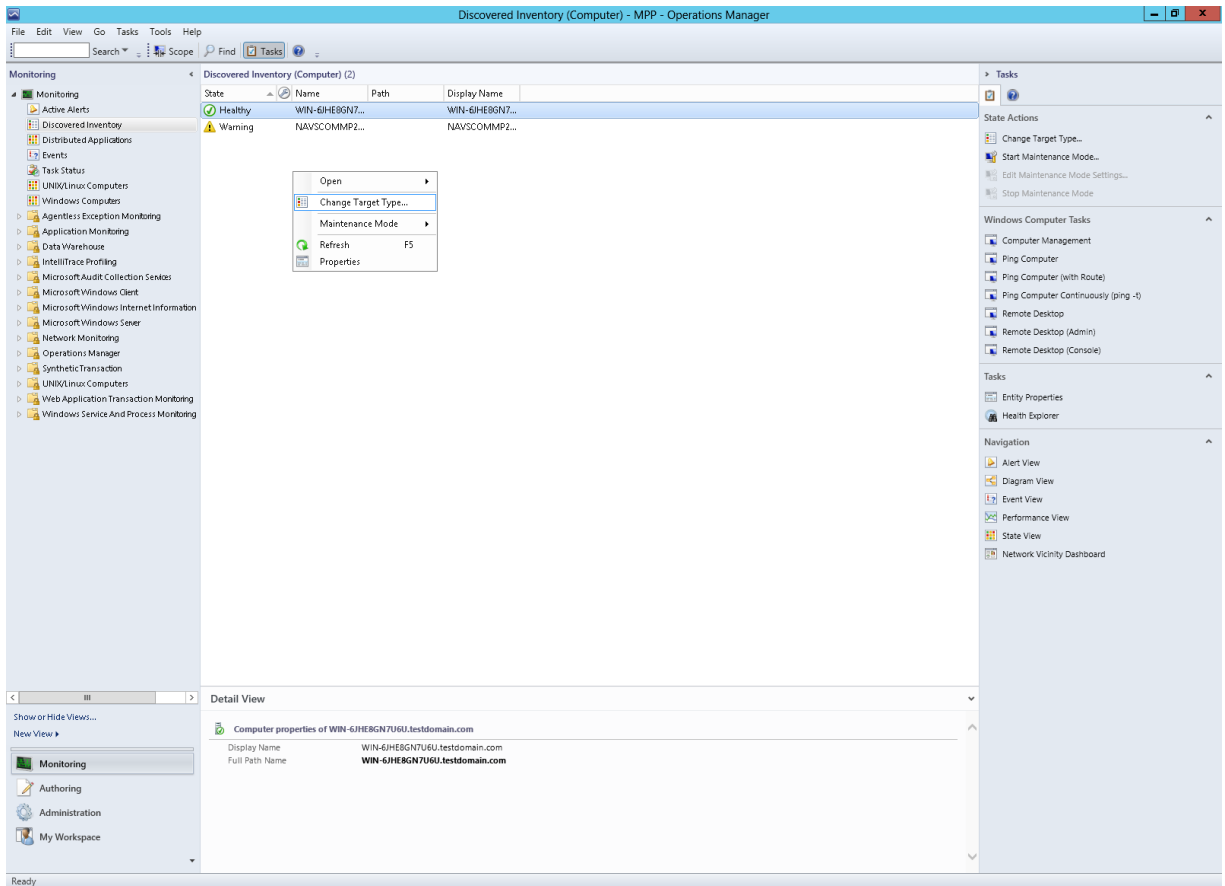

4. The **Select a Target Type** window appears.

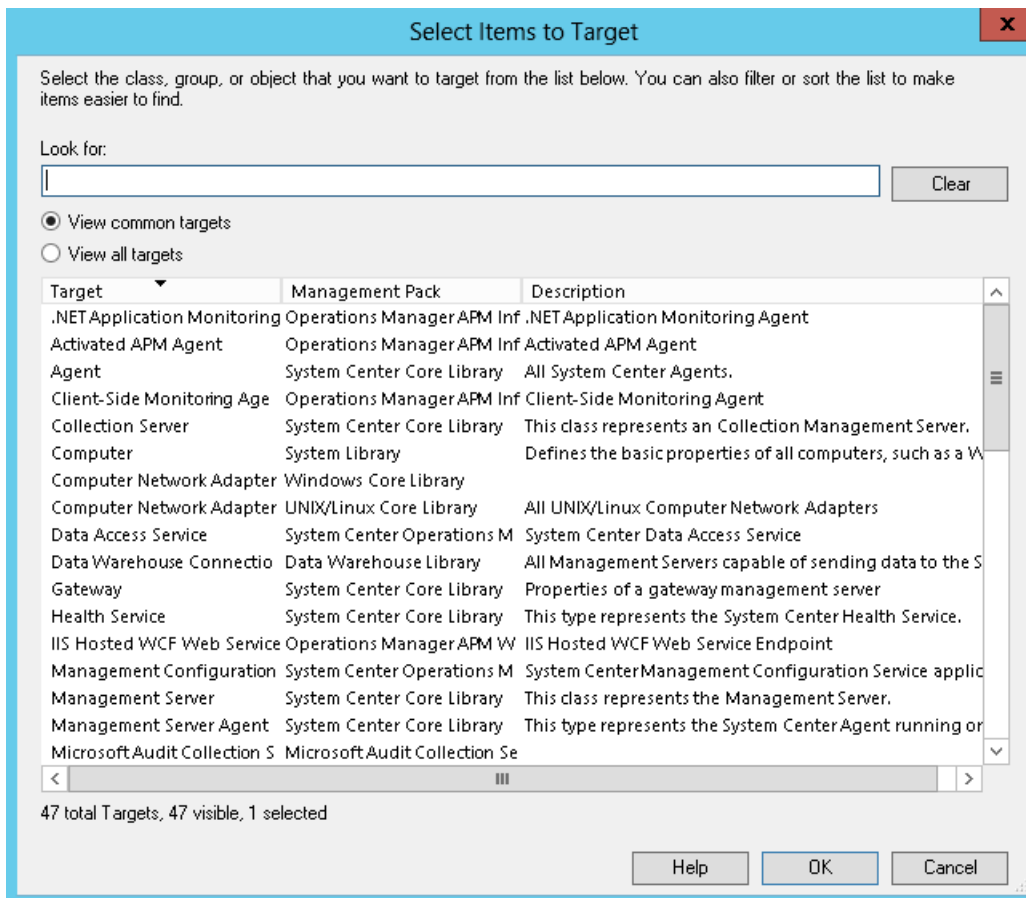

5. Click **View all targets** option.

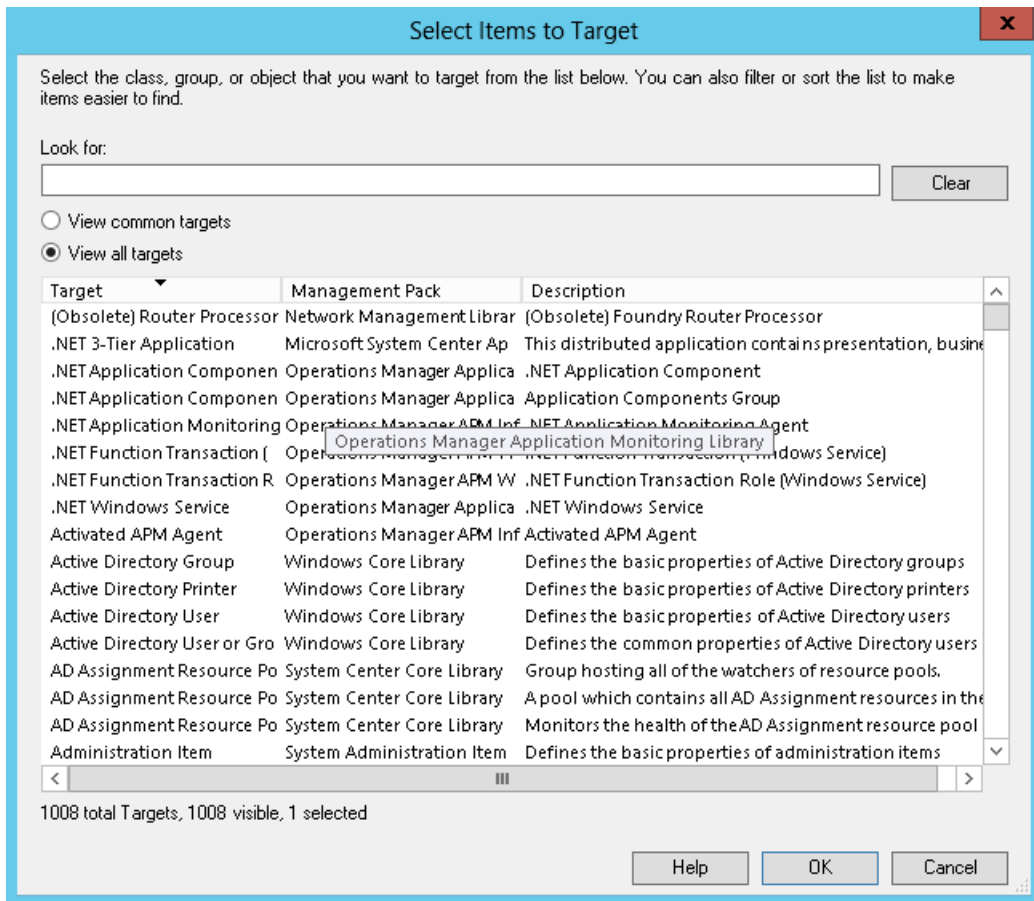

6. Select **HP Storage WEBES Listener Service Monitor** from the list.

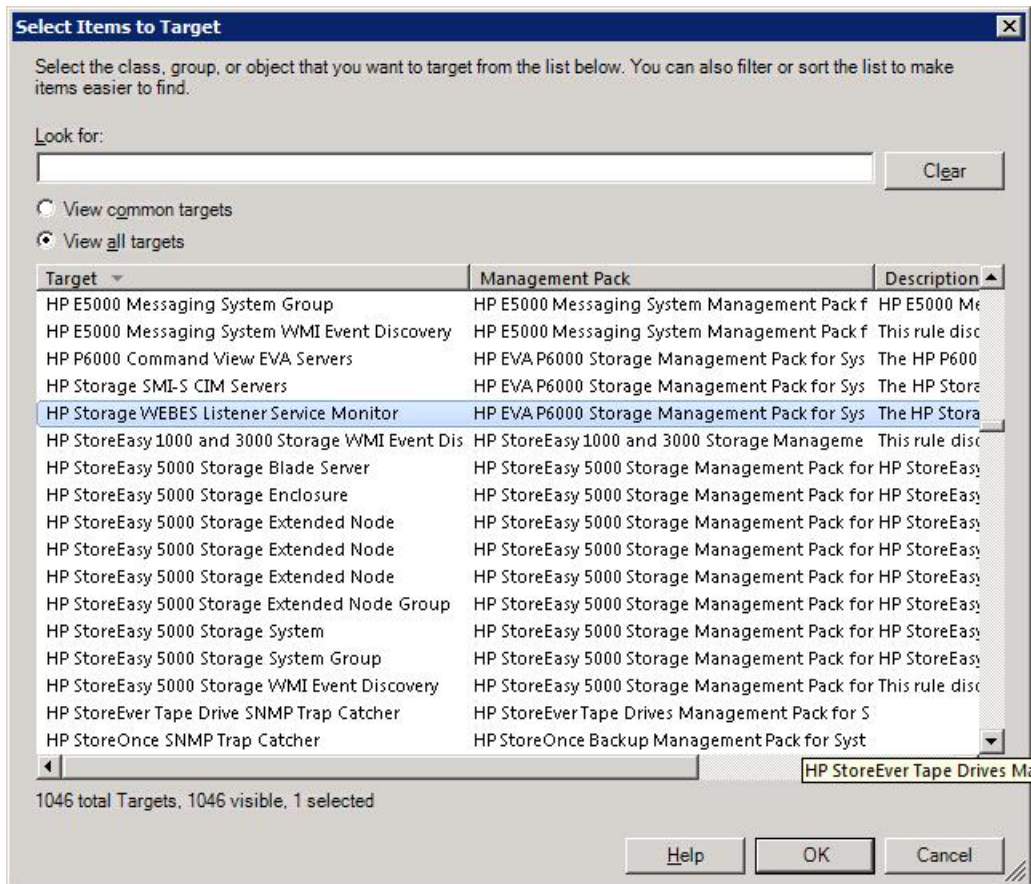

- Click **OK**. In the **Discovered Inventory** pane, all the systems in the **HP Storage WEBES Listener Service Monitor** computer group are displayed.

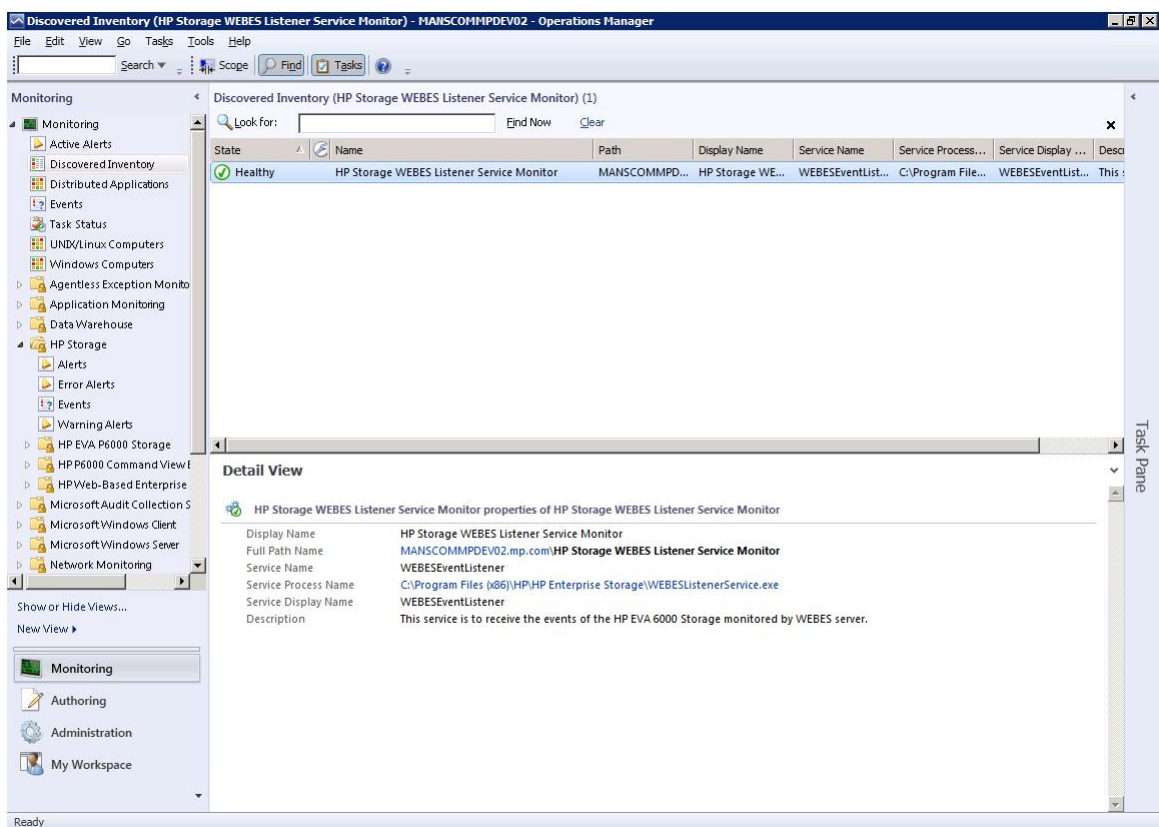

8. To view computers in other HP Storage computer groups select the following Target Types in Step 6:
  - HP 3PAR StoreServ SNMP Trap Catcher
  - HP StoreVirtual SNMP Trap Catcher
  - HP StoreOnce SNMP Trap Catcher
  - HP StoreEver Tape Library SNMP Trap Catcher
  - HP XP 9000 SNMP Trap Catcher
  - HP P2000 MSA SNMP Trap Catcher
  - HP E5000 Messaging System WMI Event Discovery
  - HP StoreEasy 5000 Storage WMI Event Discovery
  - HP StoreEasy 1000 and 3000 Storage WMI Event Discovery
  - HP Web-Based Enterprise Service Servers
  - HP Storage SMI-S CIM Servers
  - HP P6000 Command View EVA Servers
  - HP 3PAR StoreServ File Controller WMI Event Discovery

## Disabling Discoveries

The following discoveries are part of the HP Storage Management Pack:

- **HP P6000 Command View Servers Discovery**  
Discovers HP Command View servers.
- **HP Storage SMI-S CIMServer Servers Discovery**  
Discovers HP Storage SMI-S CIMServer Servers.
- **HP Storage Web-Based Enterprise Services Servers Discovery**  
HP Storage Web-Based Enterprise Services Servers Discovery.

These discoveries have been enabled by default. Complete the following steps to disable a discovery:

1. Open the **Authoring Console**.
2. Select **Object Discoveries** in the **Authoring** pane.  
The list of discovered objects is displayed in the **Object Discoveries** pane.
3. Find the discovered object in the **Object Discoveries** pane for which you want to disable the rules.
4. Right-click on the discovered object and select **Overrides+Override the Rule**.
5. Select the group or computer for which you want to disable the Discovery:

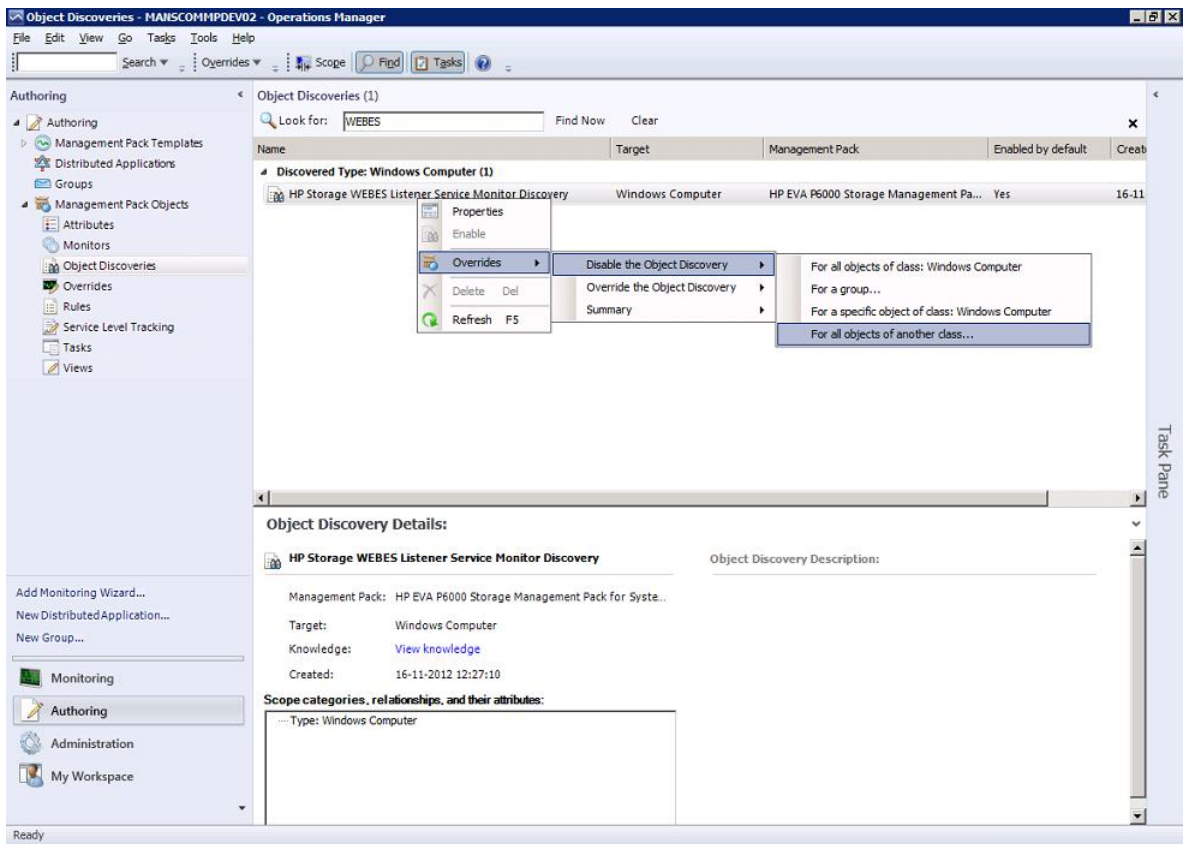

6. Select a specific object for which you want to disable Override Rule and click **OK**.
7. The **Override Properties** dialog box appears.

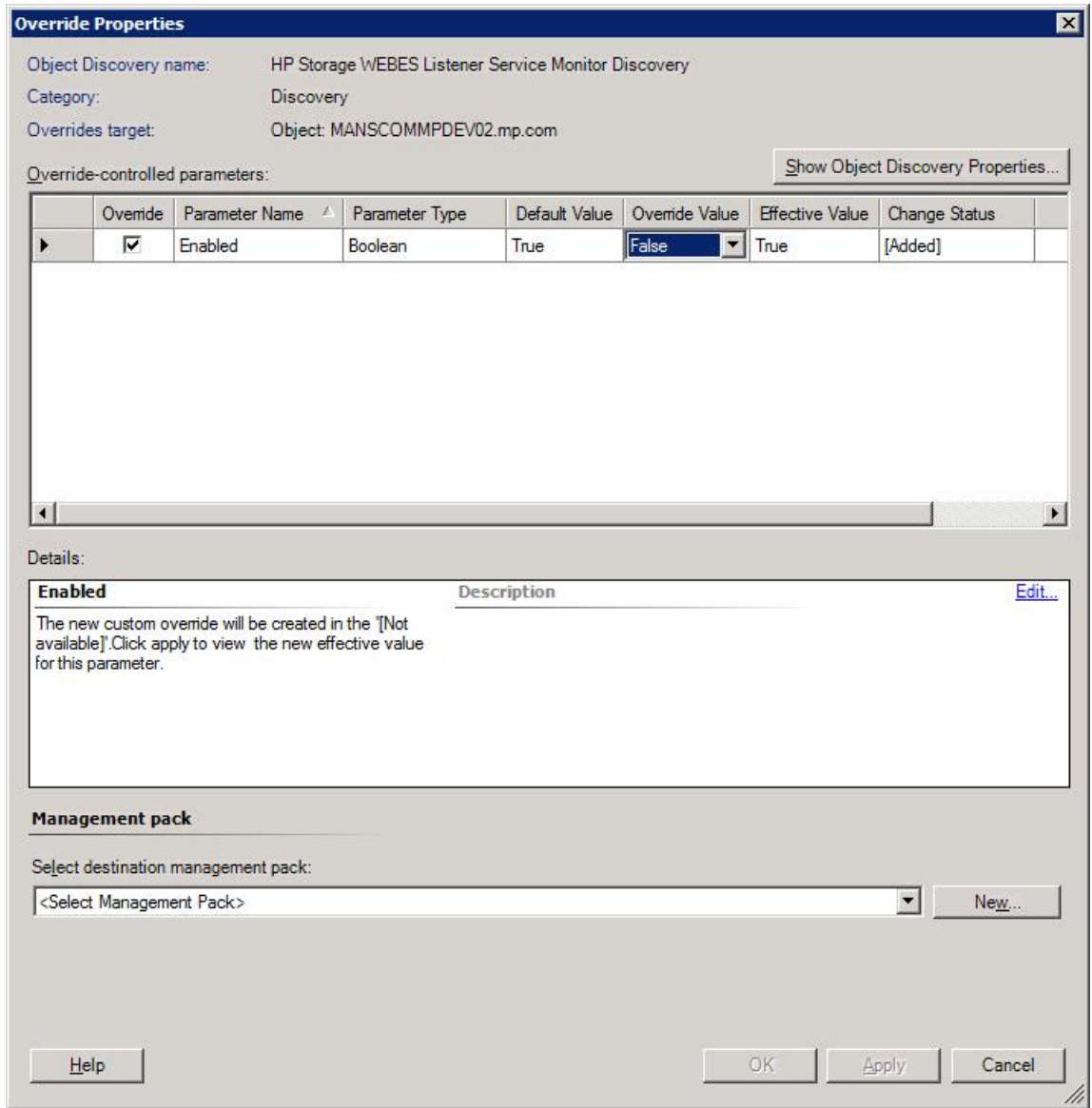

8. Select the **Enabled** Parameter and change the **Override Value** to **False**.
9. Click **Apply** and verify that the **Effective Value** of the parameter has changed to **False**.
10. Click **OK** to confirm.

**NOTE:** It is recommended to save override settings in a Custom Management Pack instead of the Default Management Pack. This will avoid creating dependency between Default Management Pack and HP Storage Management Packs.

## Monitoring HP Services Health

### Service Health Monitors

The HP Storage Management Pack installs the following service health monitors:

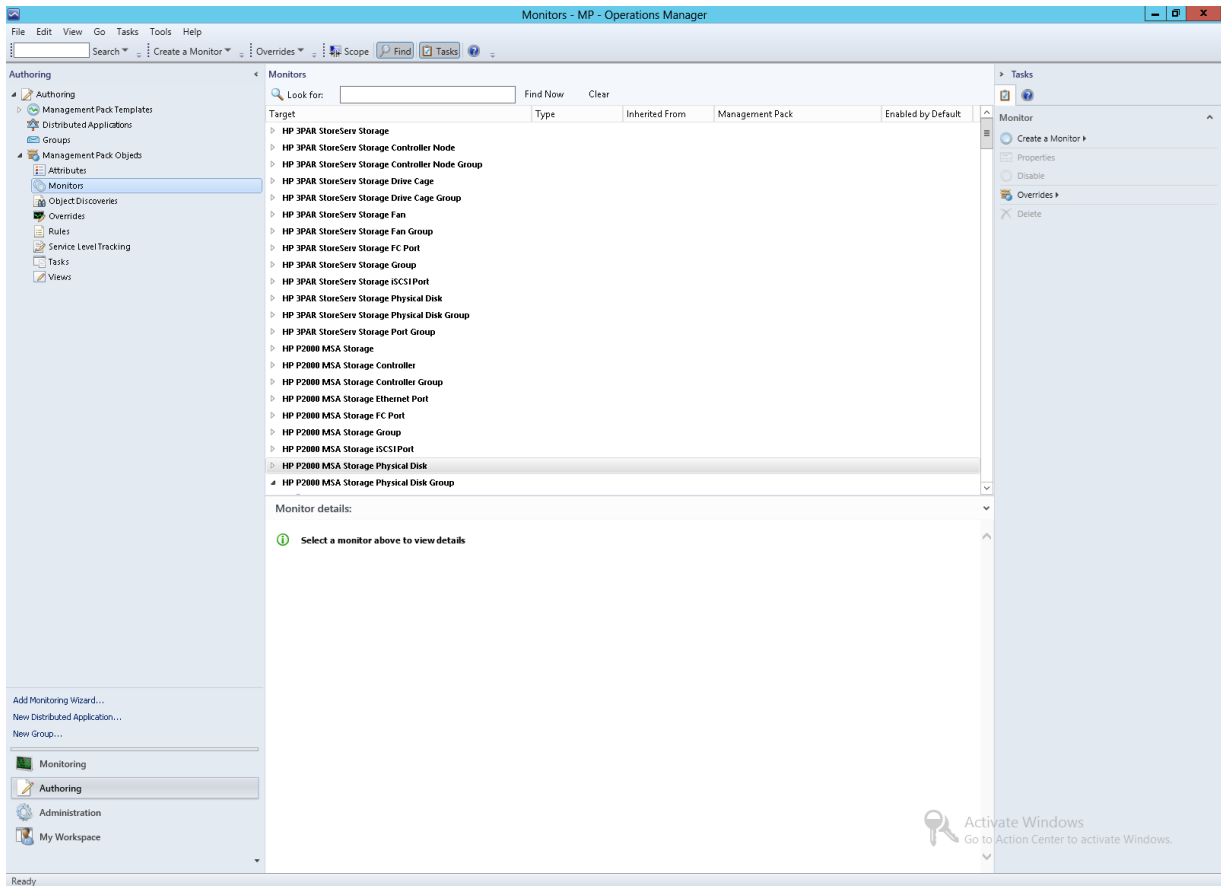

## HP P6000 Command View Service Health Monitor

Monitors the HP P6000 Command View Service Health. It generates an alert when the service stops. It tries to recover the health by attempting to automatically restart the service. To check the service health changes and recovery details view the Health Explorer.

The OpsMgr agent must be installed on the HP P6000 Command View server.

## HP Storage SMI-S CIM Service Health Monitor

Monitors the SMI-S CIM Service Health. It generates an alert when the service stops. It tries to recover the health by attempting to automatically restart the service. To check the service health changes and recovery details view the Health Explorer.

The OpsMgr agent has to be installed on the SMI-S CIM server.

## HP WEBES DESTA Service Health Monitor

Monitors the WEBES DESTA Service Health. It generates an alert when the service stops. It tries to recover the health by attempting to automatically restart the service. To check the service health changes and recovery details view the Health Explorer.

The OpsMgr agent has to be installed on the WEBES Server.

## HP WEBES DESTA WCCProxy Service Health Monitor

Monitors the WEBES WCCProxy Service Health. For more information, see [“HP WEBES DESTA Service Health Monitor”](#) (page 112)



Figure 6 Health Explorer

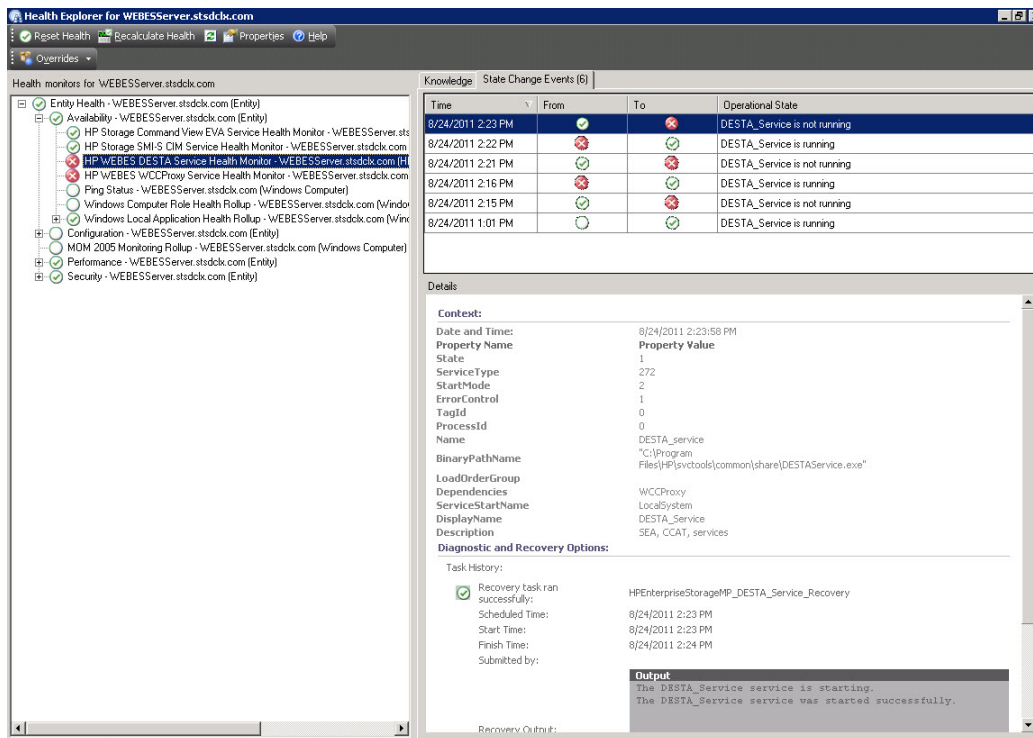

## Monitoring console

The OpsMgr **Monitoring** console displays all events and alerts generated by the HP Storage portfolio. You must perform all user activities for the HP Storage Management Pack software on the **Monitoring** console.

## Event handling

Events are collected automatically from the SNMP Trap Catcher. Depending on the event severity, an alert is generated by event rules only for error, critical error, and warning events.

## Events Details tab

The **Events Details** tab, shown in [Figure 7 \(page 114\)](#), comprises the following components:

- Event Description - Problem description, corrective action, cause of the problem, and the FRU List.
- Log Name - Name of the log file that helps in monitoring events.
- Event Number - Event number of the event in the log file. (You can edit the numbers)
- Logging Computer - Storage Management Appliance Name or Problem Reporting Node.
- Source - Name of the event.
- User - User who reports this event.
- Time - When the event was generated at reporting node.

## Event Parameters

The Event Parameters of the HP Storage have been set to the following:

- Parameter 1 - Device Id
- Parameter 2 - Device Name

- Parameter 3 - Source Computer Name - the computer that generated the event
- Parameter 4 - Source Computer Domain Name - the domain of the computer that generated the event

## Using OpsMgr Views

### HP Storage

All events and alerts generated by HP Storage hardware are shown in [Figure 7 \(page 114\)](#). The view is a consolidation of events generated by HP StoreEasy 1000/3000 Storage, HP E5000 Messaging System, HP StoreEasy 5000 Storage, HP EVA P6000 Storage, HP P6000 Command View EVA Software Suite, HP P2000 MSA Storage, HP StoreVirtual Storage, HP StoreEver Tape Libraries, HP XP 9000 Storage, HP Web-Based Enterprise Services (WEBES), HP 3PAR StoreServ Storage, HP 3PAR StoreServ File Controller, and HP StoreOnce Backup.

**Figure 7 Events in Operations Manager**

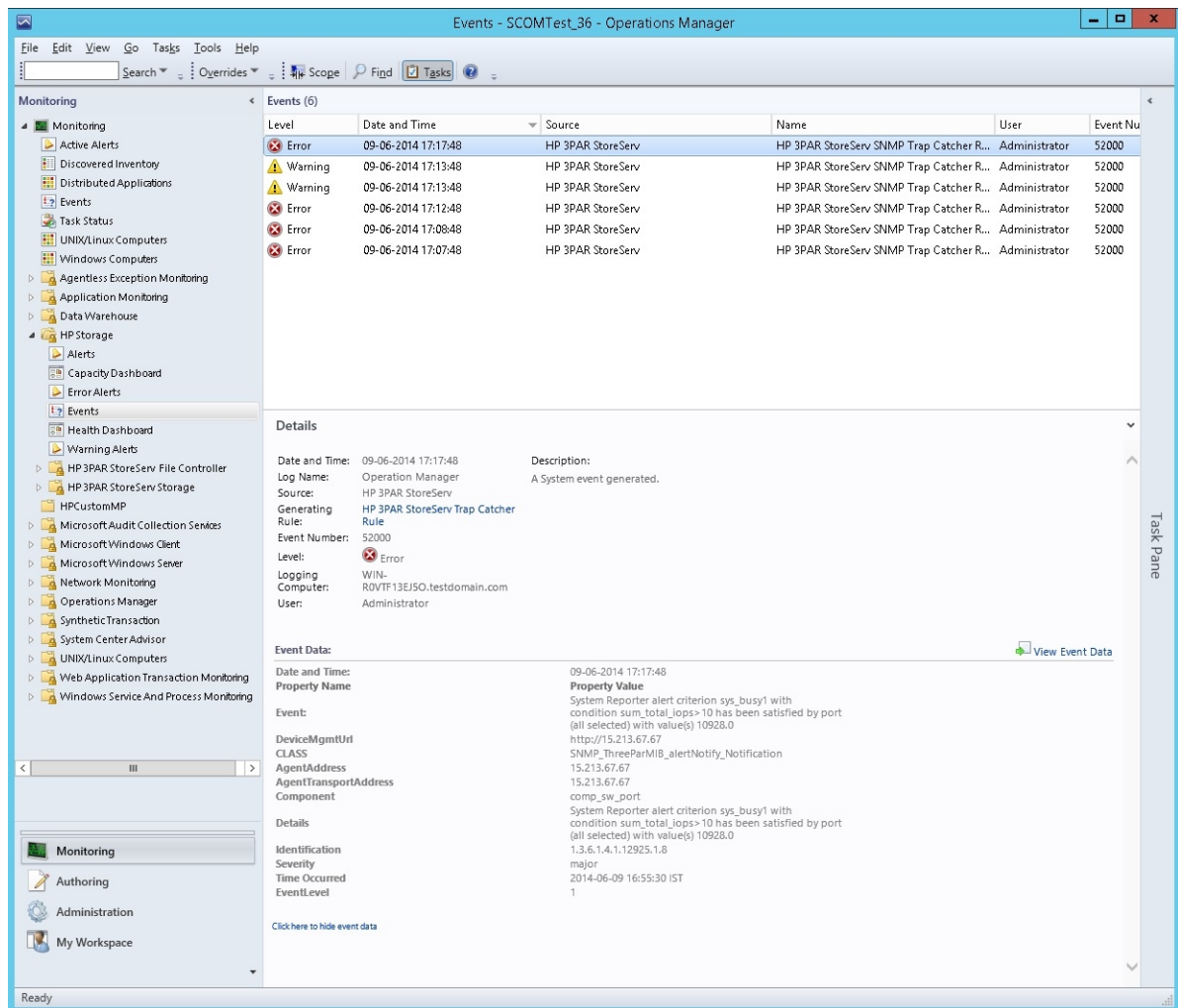

### HP 3PAR StoreServ Storage warnings and errors

Displays error and warning events from HP 3PAR StoreServ Storage.

### HP 3PAR StoreServ File Controller

Displays error and warning events from HP 3PAR StoreServ File Controller.

### HP StoreEver Tape Libraries warnings and errors

Displays error and warning events from HP StoreEver Tape Libraries.

### HP StoreVirtual Storage System

Displays events from HP StoreVirtual Storage System.

### HP P6000 Command View EVA Software Suite

Displays events generated by HP Command View Service Health Monitor and HP Storage SMI-S CIM Service Health Monitor Alerts.

### HP EVA P6000 Storage

Displays events generated by P6000/Enterprise Virtual Arrays including EVA4x00, EVA6x00, EVA8x00, P6300, and P6500.

### HP P2000 MSA Storage Arrays

Displays events from HP P2000 G3 MSA Storage.

### HP XP 9000 Storage

Displays error and warning events from P9000 Disk Arrays, including XP 24000 and P9500.

### HP Web-Based Enterprise Services (WEBES)

Displays events generated by HP WEBES DESTA Service Health Monitor and HP WEBES DESTA WCCproxy Service Health Monitor.

### HP StoreOnce Backup

Displays error and warning events from HP StoreOnce Backup.

### HP E5000 Messaging System

Displays events from HP E5000 Messaging System.

### HP StoreEasy 5000 System

Displays events from HP StoreEasy 5000 Storage System.

### HP StoreEasy 1000 Storage

Displays events from HP StoreEasy 1000 system.

### HP StoreEasy 3000 Storage

Displays events from HP StoreEasy 3000 system.

## Alerts

### Alert Details tab

Following are the components of the **Alert Details** tab:

- Source - origin of the problem.
- User - the owner of this alert.
- Causes - the cause that triggers or displays the alert.
- Resolution - the proposed fix for the Issue.
- Time - the time when the alert was generated.

The OpsMgr **Alert** window **Details** tab shown in displays problem description, corrective action, cause for the problem, and the FRU list.

## Product Knowledge tab

The Product Knowledge tab, shown in [Figure 8 \(page 116\)](#), provides context-sensitive links to external information sources, including websites and troubleshooting documents.

**Figure 8 Alert view, Product Knowledge tab**

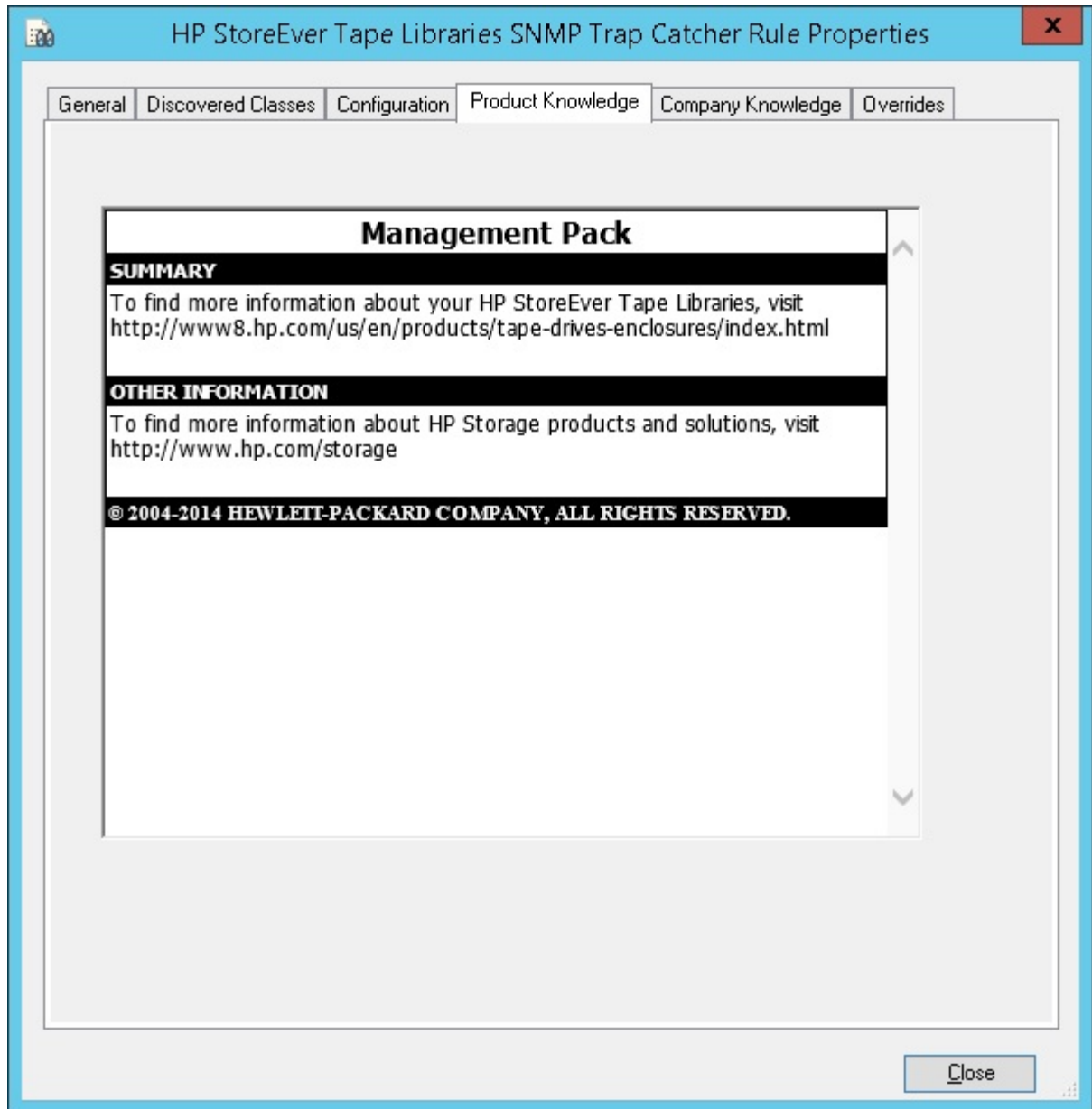

## Alerts and views

Displays alerts generated by HP Storage Management Pack. Select **Alerts** in the **HP Storage** folder on the left pane of the OpsMgr operator console. The right pane displays all alerts generated by the particular storage hardware. The alert view has a folder for each HP Enterprise Storage platform, as follows:

### HP Storage

Displays alerts generated by HP Storage hardware. The view is a consolidation of alerts generated by HP 3PAR StoreServ Storage, HP E5000 Messaging System, HP EVA P6000 Storage, HP P6000 Command View EVA Software Suite, HP StoreEasy 1000/3000 Storage, HP StoreEasy 5000 Storage, HP 3PAR StoreServ File Controller, HP StoreEver Tape Libraries, HP StoreOnce Backup,

HP P2000 MSA Storage, HP StoreVirtual Storage, HP Web-Based Enterprise Services(WEBES)and HP XP 9000 Storage.

#### [HP StoreEver Tape Libraries warnings and errors](#)

Displays warning and error alerts generated by HP StoreEver Tape Libraries.

#### [HP 3PAR StoreServ Storage warnings and errors](#)

Displays warning and error alerts generated by HP 3PAR StoreServ Storage.

#### [HP StoreVirtual Storage warnings and errors](#)

Displays warning alerts generated by HP StoreVirtual Storage.

#### [HP P6000 Command View EVA Software Suite warnings and errors](#)

Displays warning, critical, and error alerts generated by the HP Storage Command View Service Health Monitor and HP Storage SMI-S CIM Service Health Monitor Alerts.

#### [HP EVA P6000 Storage warnings and errors](#)

Displays warning, critical, and error alerts generated by P6000/ Enterprise Virtual Arrays, including EVA4x00, EVA6x00, EVA8x00, P6300, and P6500.

#### [HP P2000 MSA Storage Array warnings and errors](#)

Displays warning, critical, and error alerts generated by HP P2000 G3 MSA Storage.

#### [HP XP 9000 Storage warnings and errors](#)

Displays warning, critical, and error alerts generated by HP XP 24000 and P9500 Storage Arrays.

#### [HP Web-Based Enterprise Services \(WEBES\) warnings and errors](#)

Displays alerts from HP WEBES DESTA Service Health Monitor and HP WEBES DESTA WCCproxy Service Health Monitor.

#### [HP StoreOnce Backup warnings and errors](#)

HP StoreOnce Backup warnings and errors.

#### [HP E5000 Messaging System warnings and errors](#)

Displays warning and error alerts generated by HP E5000 Messaging System.

---

**NOTE:** The HP Storage Management Pack supports events only from the chassis and storage components of E5000 Messaging System. For more information on how to monitor events from blade servers in an E5000 Messaging System, see the E5000 Messaging System product documentation.

---

#### [HP StoreEasy 5000 Storage warnings and errors](#)

Displays warning and error alerts generated by HP StoreEasy 5000 System.

---

**NOTE:** The HP Storage Management Pack supports events only from the chassis and storage components of StoreEasy 5000 System. For more information on how to monitor events from blade servers in an StoreEasy System, see the StoreEasy 5000 System product documentation.

---

#### [HP StoreEasy 1000 Storage](#)

Displays warning and error alerts from HP StoreEasy 1000 system.

#### [HP StoreEasy 3000 Storage](#)

Displays warning and error alerts from HP StoreEasy 3000 system.

## HP 3PAR StoreServ File Controller

Displays warning and error alerts from HP 3PAR StoreServ File Controller.

# 5 Using HP Storage Management Pack PowerShell Cmdlets

From version 4.1, HP Storage Management Pack contains PowerShell Cmdlets that can be used to automate the management pack related tasks. You can perform the following tasks by using these PowerShell Cmdlets:

- Configuring rules
- Getting events and alerts
- Getting diagram view information

## Prerequisites

PowerShell Cmdlets are supported from SCOM 2012 and later versions. There are no additional pre-requisites for using PowerShell Cmdlets. Pre-requisites such as SNMP or SNMP trap services that are required for the normal Management Pack operations are applicable here.

## Using HP Storage Management Pack PowerShell Cmdlets

Perform the following steps to use HP Storage Management Pack PowerShell Cmdlets:

1. Open the PowerShell command line interface.
2. Import the HP Storage Management Pack module by using the following command:

```
Import-Module HPStorageMP
```

3. Run the PowerShell Cmdlets.

For example, run the following command to enable the event rule for HP 3PAR StoreServ Storage:

```
Enable-HPStorageEventRule -ManagementServer  
"<PrimaryManagementServername>" - DeviceType "HP 3PAR StoreServ"  
-targetsystem "<Host Name>" -CustomMP Custom
```

## List of PowerShell Cmdlets for HP Storage Management Pack

The following PowerShell Cmdlets can be used to configure and get the alerts and diagram view information from the HP Storage Management Pack:

Cmdlets Name	Purpose
Enable-HPStorageMPEventRule	Enable the rule related to event for specific storage system.
Disable-HPStorageMPEventRule	Disable the rule related to event for specific storage system.
Enable-HPStorageMPDiscoveryRule	Enable the rule related to diagram specific storage system.
Disable-HPStorageMPDiscoveryRule	Disable the rule related to diagram specific storage system.
Show-HPStorageMPEventRuleSummary	Display the override summary of the rule to events.
Show-HPStorageMPDiscoveryRuleSummary	Display the override summary of the rule to diagram view.
Remove-HPStorageManagementPack	Delete the specific Management pack from SCOM
Show-HPStorageMPAllEvents	Display all the HP Storage events created in SCOM.
Show-HPStorageMPEvents	Display the specific HP Storage events based on severity and device type.
Show-HPStorageMPAllAlerts	Display all the HP Storage alerts created in SCOM.
Show-HPStorageMPAlerts	Display the specific HP Storage alerts based on severity and device type.
Modify-HPStorageMPDiscoveryRule	Modify the override value of rule related to diagram view.

Cmdlets Name	Purpose
Export-HPStorageMPAlerts	Export all the HP Storage alerts to CSV file (HPStorageMPAlerts.csv) and stored at install directory path.
Export-HPStorageMPEvents	Export all the HP Storage events to CSV file (HPStorageEvents.csv) and stored at install directory path.
Show-HPStorageMPDiagramView	Display instance of diagram of specific storage type.
Export-HPStorageMPDiagramView	Export all the HP Storage diagram view instances to CSV file (HPStorageDiagramView.csv) and stored at install directory path.
Connect-HPStorageMPManagementServer	Verify and connect to the management server.
Add-HPStorage	Discover the HP Storage system for the diagram view. For configuring HP 3PAR StoreServ Storage for Capacity Dashboard and Virtual Machines, use <a href="#">Discovery of HP Storage devices using HP Storage Management Pack User Configuration Tool</a>
Remove-HPStorage	Remove the HP Storage system that is discovered for the diagram view. For removing HP 3PAR StoreServ Storage for Capacity Dashboard and Virtual Machines, use <a href="#">Discovery of HP Storage devices using HP Storage Management Pack User Configuration Tool</a>
Modify-HPStorage	Modify the credentials or IP of HP Storage system for the diagram view. For modifying HP 3PAR StoreServ Storage for Capacity Dashboard and Virtual Machines, use <a href="#">Discovery of HP Storage devices using HP Storage Management Pack User Configuration Tool</a>
Modify-HPStorageManagementServer	Modify the IP of the SCOM management server.

Use the following command to know the syntax of each cmdlet:

```
Get-Help <cmdlet-name>
```

For example, use `Get-Help Add-HPStorage` to know the syntax of Add-HPStorage cmdlet.



---

## 6 Frequently Asked Questions

### HP Systems Insight Manager

Q1. How does HP SIM compare to OpsMgr and why should I use both?

A1. OpsMgr and HP SIM are complementary management tools.

HP SIM provides hardware resource life cycle management for HP servers, clients, printers, and other standards-based devices. It combines and displays:

- in-depth health and configuration information
- group management
- version control for HP system software
- remote administration through HP Lights-Out management processors

This extensive application along with HP Essentials value-added software can also provide advanced hardware performance, administration and vulnerability management.

Within an IT infrastructure, HP SIM and the HP Essentials Value Packs are for organizations that are responsible for proper configuration, timely update, security, and health of hardware resources.

OpsMgr delivers comprehensive monitoring, performance management and analysis tools to maintain Windows operating systems and application platforms. Microsoft relies on industry partners like HP and others to provide additional hardware and software management solutions. This will further extend OpsMgr to meet the needs of customers' enterprise environments. Implementing both OpsMgr and HP SIM provides well-integrated and complementary benefits, which help to manage adaptive enterprise environments.

### Platform Support

Q1. What hardware platforms is supported by the new HP Storage Management Pack for System Center?

A1. The HP Storage Management Packs for System Center supports:

- HP 3PAR StoreServ Storage System
- HP Storage ESL E-Series, EML E-Series, ESL 6000/9000/12000, MSL Series
- HP P2000 MSA G3 and HP MSA 2040 Storage
- HP Storage EVA P6000, 4x00, 6x00, 8x00, P6300, P6500, and HP P6000 Command View EVA Software
- HP Storage XP 24000 and P9500 Arrays
- HP StoreVirtual Storage with SANiQ 9.5, 10.5, and 11.0
- HP E5000 Messaging System
- HP StoreEasy 5000 Storage System
- HP StoreOnce Backup
- HP StoreEasy 1000 and HP StoreEasy 3000 Storage
- HP 3PAR StoreServ File Controller

Q2. Why aren't my HP informational events showing up as alerts under OpsMgr?

A2. The HP Storage Management Pack for System Center only generates alerts in OpsMgr for critical and warning states. Check the events view for a complete list and events.

## Known Behavior

- Unable to collect SNMP traps from HP Storage Management Pack for System Center.  
Microsoft has implemented a workaround from OpsMgr to move the SNMP trap collection server to a separate Management server which is not a part of Network Resource Pool/Discovery Server. This will allow the SNMP Trap service to listen on port 162 and collect traps.
- For the Diagram view of HP P2000 MSA, unknown state is unavailable in Microsoft SCOM, thus it is interpreted as OK .
- To discover HP P2000 MSA Storage, please add only one controller IP in the User Configuration Tool. If both the controller IPs are added, then diagram view will show the Storage system IP as the second IP controller (which ever is added later).
- The health of HP StoreVirtual Storage VSA model displays a warning for the network component in OpsMgr console. However, the HP StoreVirtual Centralized Management Console shows healthy.
- Monitoring HP Storage diagram view is not supported from the OpsMgr Gateway server.
- Network Resource Pools are available in SCOM 2012.
- The Left Power Supply health is incorrectly shown as healthy when it is degraded or failed in the Diagram View of MSA 2040.
- A new feature in System Center 2012 – Operations Manager is the resource pool. A resource pool is a collection of management servers used to distribute work amongst themselves and take over work from a failed member.

You can use resource pools for:

- Monitoring network devices.
- Monitoring UNIX and Linux computers.
- Create Resource Pool: <http://technet.microsoft.com/en-us/library/hh230706.aspx>

## Troubleshooting

### Installer

Q1. The HP Storage Management Pack for System Center kit fails with error “The scripts required for this install to complete could not be run”.

A1. Please install the SNMP Service on the OpsMgr Server before installing the HP Storage Management Pack for System Center. The installation program runs a script which requires the smi2smir tool to register SNMP MIBS related to HP Storage devices. The smi2smir tool can be located in the `~SYSTEM32\wbem\snmp` directory for a 32-bit operating system and `~SysWOW64\wbem\snmp` directory for a 64-bit operating system. Tool gets installed when you install SNMP on Windows servers.

Q2. I have installed the HP Storage Management Pack for System Center v4.1 for OpsMgr; however I have deleted the management pack imported during installation manually. Can repair option of installer re-import the management pack?

A2. Yes, the repair option of the installer will re-import the management pack selected during the installation. The repair option will also re-install the install directory files, registry path, and mibs.

Q3. Repair of HP Storage Management Pack does not start the web-service.

A3. The repair option does not automatically restart the web services. Perform the following steps to start the services manually:

1. Navigate to Start>Run.
2. In the Run dialog enter `services.msc` and click enter to list all services.
3. Select the **HP Storage Management Pack Server** and start the service.

## SNMP

Q1. I am not able to see anything after creating the View with target as SNMP Trap Catcher Discovery.

A1. Check if the **SNMP Trap Catcher Discovery Rule** in the authoring pane is disabled. If it is disabled, enable the rule.

Q2. I have created the view with Object as SNMP Trap Catcher Discovery in the OpsMgr console. I could see some Events\Alerts from the monitoring device but not in readable format.

A2. If you are using the Microsoft Windows Server 2003, open the command prompt and navigate to this folder: `../windows/system32/wbem/snmp`.

If you are using Microsoft Windows Server 2008, open the command prompt and navigate to this folder: `../windows/SysWOW64/wbem/snmp`.

Run the command `smi2smir/1` to get a list of `.mib` files registered in WMI. If you are not able to find `.mib` files registered, reinstall the HP Storage Management Pack and also check if the installed management pack kit supports the installed version of the Windows operating system.

## Diagram View

Q1. I have discovered the HP Storage device using the HP Storage Management Pack User Configuration tool. I have enabled the discovery rule, and diagram view is also displayed. Now, I have disabled the discover rule. Why is the diagram view still displayed?

A1. The disabling of the discovery rule will not remove the diagram view instance from OpsMgr console, however the instance of diagram view will not be refreshed. To remove the instance of storage device, delete the entry from the HP Storage Management Pack User Configuration tool.

## Collection Point Server

Q1. I have installed HP Storage Management Pack v3.1, and have discovered the HP Storage device using the HP Storage Management Pack User Configuration tool. I have enabled the discovery rule for the diagram to collection point server. Why is the diagram view not displayed?

A1. Ensure that PowerShell is installed in the collection point server, since discovery rule for the diagram view needs PowerShell to be present on the target system or collection point. If the PowerShell is not present, error events bearing Event ID 21400 will be thrown in the Operation Manager log in collection point server. Hence, ensure that PowerShell is installed on the machine.

Q2. I have installed the HP Storage Management Pack for System Center v4.1 on collection point server, discovered the HP P2000 MSA Storage using HP Storage User Configuration tool, and enabled the discovery rule in OpsMgr. Why is the diagram view not displayed in OpsMgr?

A2. By default, the `PowerShell.exe` disables the execution of the PowerShell script. Perform the follow steps to enable the same:

1. Launch the `PowerShell.exe`.
2. Execute the following command:  
`Set-ExecutionPolicy RemoteSigned`
3. Enter `Y`.

Q3. I have installed the HP Storage Management Pack for System Center 4.1 on collection point server. Why am I getting an error while connecting to the OpsMgr server using HP Storage User Configuration tool.

A3. By default, the domain firewall is enabled on the collection point and the OpsMgr server. Ensure that the firewall on the collection point and the OpsMgr server is disabled and then try connecting to the OpsMgr server using HP Storage User Configuration tool.

## Dashboards

Q1. I am unable to view the Health Dashboard.

A1. This occurs when the GUI controls are not loaded due to cached data in OpsMgr. To resolve this issue, perform the following steps:

1. In the CMD prompt, enter `<OpsMgr Installed directory>\Console`.  
For SCOM 2012 R2, navigate to the following the installed directory: `c:\Program Files\Microsoft System Center 2012 R2\Operations Manager`.

2. Run `Microsoft.EnterpriseManagement.Monitoring.Console.exe /clearcache`

Q2. I am getting the following error message : CapacityConfigFile.xml file is missing from the Install directory.

Ans : To resolve this issue, perform the following:

1. In the User Configuration Tool, connect to the Management server.
2. The Capacity Config file is created.

Q3. I get the following error message : Web-services not running:

A3.T resolve the error, perform the following:

1. Navigate to Start>Run.
2. In the services window, enter `services.msc`.

You will get a list of services.

3. Select the service **HP Storage Management Pack Server** and start the service.  
option to open the Run dialog box. Open the by typing "" in the box. Click enter.

Q4. I am unable to view the graph and I get the following message : Insufficient data points to display the graph (Minimum 2 data points required)

A4 : To display a line graph hourly, daily and monthly at least 2 data points are required. The polling of the data points starts one hour after installation. For a newly configured storage system or CPGs/Virtual Volumes, the graphs display after 2 hours from the time of configuration or creation. It is recommended to use hourly/daily graph till daily/monthly graph are available.

Q5. I have configured HP 3PAR StoreServ Storage and created CPG or volumes. After three hours the graph is displayed but the capacity changes are not reflecting.

A5: The capacity changes are displayed after the next polling cycle (within an hour).

Q6. I have upgraded HP Storage Management Pack for System Center from V4.0 to V4.1, however HP 3PAR Storage discovered is not displayed in the Capacity dashboard.

A6. If the HP Storage Management Pack was upgraded from v4.0 to v4.1 , modify the HP 3PAR Storage discovered with same credentials using the HP Storage Management Pack User Configuration Tool and reconfigure HP Storage Management Server services.

## Devices

### HP 3PAR StoreServ

Q1. I am not able to see anything after creating the View with target as **HP 3PAR StoreServ Trap Catcher Rule** and **HP 3PAR StoreServ Discovery Rule**.

A1. Check if the **HP 3PAR StoreServ SNMP Trap Catcher Rule** and **HP 3PAR StoreServ Storage Discovery Rule** in the authoring pane is disabled. If it is disabled, enable the rule.

Q2. I have created the view with Object as **HP 3PAR StoreServ SNMP Trap Catcher Rule** and **HP 3PAR StoreServ Storage Discovery Rule** in the OpsMgr console. I could see some Events\Alerts from the monitoring device but not in readable format.

A2. If you are using the Microsoft Windows Server 2003, open the command prompt and navigate to this folder: `../windows/system32/wbem/snmp`.

If you are using Microsoft Windows Server 2008, open the command prompt and navigate to this folder: `../windows/SysWOW64/wbem/snmp`.

Run the command `smi2smir/1` to get a list of `.mib` files registered in WMI. If you are not able to find `.mib` files registered, reinstall the HP Storage Management Pack and also check if the installed management pack kit supports the installed version of the Windows operating system.

Q3. I have installed the HP 3PAR StoreServ Storage Management Pack for System Center v4.1 for OpsMgr 2012 R2 and enabled **SNMP Trap Catcher Rule** on OpsMgr server. Why am I not able to receive any 3PAR traps?

A3. Before enabling the trap catcher ensure that the traps reach the OpsMgr server. If the OpsMgr server is part of the network resource pool, the windows SNMP trap service is disabled due to which the traps will not be received on OpsMgr server. Hence, ensure that the OpsMgr server is not part of the network resource pool, which is an OpsMgr known limitation. See the link to know more about OpsMgr 2012 limitation <http://technet.microsoft.com/en-us/library/jj656656.aspx>.

This behavior is applicable to other storage device SNMP traps not only for HP 3PAR StoreServ Storage.

Q4. I have installed the HP 3PAR StoreServ Storage Management Pack for System Center v4.1 for OpsMgr 2012 R2, discovered the HP 3PAR in User Configuration tool and also enabled discovery rule. Diagram view is displayed in the 3PAR StoreServ diagram view folder. Why is the health state of HP 3PAR StoreServ Storage group not stable?

A4. This is one of the know limitation of OpsMgr 2012 and OpsMgr 2012 R2. The group state becomes stable after few seconds interval of time.

---

**NOTE:** This behavior is applicable to other storage device diagram view supported not only for HP 3PAR StoreServ Storage.

---

Q5. I have installed the HP 3PAR StoreServ Storage Management Pack for System Center v3.0 or later and enabled SNMP Trap Catcher Rule on OpsMgr server. Why am I not able to receive any 3PAR traps and a warning event with ID 10353 is continuously generated?

A5. Before enabling the trap catcher, ensure that the SNMP Trap services are running target server where SNMP Trap Catcher Rule is enabled.

## HP P2000 MSA

Q1. Why is P2000 MSA Storage System (or any other storage System state for that matter), shown as degraded, when it has logical failures but no physical failures?

A1. Since Health State of P2000 MSA Storage is dependent on both Logical and Physical components failures, the state of P2000 MSA is shown as degraded.

This is an expected behavior in every Storage System Management Pack with the diagram view. Storage system health state is directly fetched from the device that shows overall health state including physical and logical failures. For sub-components, only physical components are modelled.

In case of a logical error, that is, when there is no physical error, health state of Storage system may differ from the collective health state of the sub-components.

Q2. Do we need to add the IPs of both the P2000 MSA controllers through the User Configuration tool? What is the impact if we do so?

A2. To discover P2000 MSA Storage, add only one controller IP in the User Configuration tool. If both controller IPs are added, there is no impact on functionality. However, the diagram view will show the storage system IP as the IP of the second controller, whichever is added later.

Please clarify

Q3. I have installed the HP 3PAR StoreServ Storage Management Pack for System Center v4.0 or later and port 8080 is closed. Is there any issue with Web Service Communication?

A3. If the SCOM management server is not opened port 8080 with the collection point will never be able to communicate with the web service on the SCOM management server. So Port 8080 should be opened.

## HP EVA P6000

Q1. I am using the WEBES XML interface. The first time I ran the `desta mom` on command, it did not prompt me for the host name and port number. What do I do?

A1. If you are not prompted for the host name and port information, run the command again (note that you may need to run `desta mom` off first, depending on the version of WEBES you are using). Then, re-run the command.

For more information regarding this process, see [“Configuring WEBES to send an XML event callout” \(page 14\)](#).

Q2. The WEBES configuration `desta mom` defaulted to port 2069 instead of 8945. What do I do?

A2. The port number needs to be the same in both the WEBES `desta mom` configuration and the OpsMgr Management Pack configuration. [“Configuring WEBES to send an XML event callout” \(page 14\)](#) contains instructions for changing the port you are using; be sure both of the configurations are using the same port.

Q3. The systems running WEBES Event Listener when discovered are not getting displayed in the [“View Discovered Inventory” \(page 105\)](#) pane.

A3. Ensure that you have selected the right computer group and then refresh the **Monitoring** pane. If the problem still persists, you may need to restart the system running OpsMgr server.

Q4. I'm not getting WEBES events and alerts. WEBES and ISEE are working properly.

A4. To verify the communication path from the WEBES through the WEBES Listener to the OpsMgr in your environment, follow these steps:

1. On the system running the WEBES Event Listener, verify if the WEBESListener service is installed/running.  
(**Control Panel+ Administrative Tools+ Services**).
2. On both WEBES as well as WEBES Listener systems, verify if there are no firewalls blocking the port.
3. Try to telnet from WEBES Server to WEBES Listener server:  
> telnet <IP address of WEBES Listener Server> 8945  
You should get a login screen if the port is active.
4. Enable debug on the WEBES Listener service:
  - a. Stop the WEBESListener service.
  - b. Set the debug level in the `config.txt` file to 4 which can be found at:
    - `~\Program Files\HP\HP Storage Management Pack for System Center` directory for a 32-bit operating system
    - `~\Program Files (x86)\HP\HP Storage Management Pack for System Center` directory for a 64-bit operating system
  - c. Restart the WEBESListener service.

- d. On the WEBES system, generate the EVA P6000 test events. For more information, see [“Generating WEBES test event” \(page 91\)](#)
- e. You should see the test events scroll across the screen. To verify if they were sent properly, go to the event viewer on the system running the WEBESListener application, and check the Application log of Windows. The events are logged by the WEBESEventListener.
- f. If the events show up in the Application log of Windows, they are being properly processed by the WEBES Event Listener. Stop the service, reset the debug level to 2 in the `config.txt` file, and restart the service. Move to the OpsMgr management station to continue troubleshooting.
- g. If you do not see the events in the Application log, please collect the `WEBESEventListener.log` file and contact HP Support team. See [“Support Information” \(page 131\)](#)

The `WEBESEventListener.log` file can be found at:

- `~\Program Files\HP\ HP Storage WEBES Listener for System Center` directory for a 32-bit operating system
- `~\Program Files(x86)\HP\ HP Storage WEBES Listener for System Center` directory for a 64-bit operating system

---

**NOTE:** If the alert generated from WEBES is **SEA Test** alert, only the Application Log is created and the alert will not be seen in the OpsMgr console.

---

Q1. I am using HP Storage Management Pack for Monitoring EVA alerts. Events sent from WEBES does not reach OpsMgr and the `webesListenerlog.log` file grows very large.

A1. We have released a customer advisory on this issue. You can download this from the following website: [http://saw.cce.hp.com/km/saw/view.do?docId=emr\\_na-c01581401](http://saw.cce.hp.com/km/saw/view.do?docId=emr_na-c01581401).

Q2. During upgrade of WEBES Listener Service on Microsoft Windows Server 2003 systems, it does not give a warning message to the user before stopping and replacing the executable.

A2. It's a windows behavior on Microsoft Windows Server 2003 systems which has been overcome in Microsoft Windows Server 2008 systems.

Q3. Why does the installation of HP Storage WEBES Listener for System Center fail on Windows Server 2012 or later?

A3. HP Storage WEBES Listener installer requires .Net framework v3.5 on the Windows Server 2012. However, .Net v4.5 is enabled on Window Server 2012 by default. Hence, enable the .Net framework v3.5 on the server and try to install again.

## E5000 / HP StoreEasy 5000

Q1. I am able to see duplicate events from one E5000 Messaging System/HP StoreEasy 5000 Storage System in the OpsMgr console.

A1. Monitor only one blade server from the E5000 Messaging System/HP StoreEasy 5000 Storage System. For more information, see .

Q2. I have installed the HP Storage Management Pack 3.0 or later, and discovered the E5000 Messaging/ HP StoreEasy 5000 Storage Systems using OpsMgr Discovery Wizard. The firewall settings of the E5000/ HP StoreEasy 5000 Storage system are in the **ON** mode. I am not able to see the Diagram View for the E5000/ HP StoreEasy 5000 Storage system.

A2. To confirm if the issue is with the firewall settings of the E5000/ HP StoreEasy 5000 Storage system, click **Event Viewer > Applications and Services logs > Operations Manager logs**. Check if an error is logged with **ID100** and the description “Error: RPC server is unavailable <system name>”.

To get the Diagram View, **OFF** the firewall settings of the E5000 Messaging/ HP StoreEasy 5000 Storage System and check again.

Q3. I have installed HP Storage Management Pack 3.0 or later and generated the events for E5000 Messaging System in the OpsMgr console . After some time, I uninstalled the HP Storage Management Pack 3.0 or later. Why are the old events still seen even after uninstallation of HP Storage Management Pack 3.0 or later?

A3. For information on this scenario, please see Microsoft System Center Operations Manager Operations User's Guide.

Q4. The discovery rule for the E5000/HP StoreEasy 5000 Storage system runs every 360 seconds on the OpsMgr. How do I discover the E5000/HP StoreEasy 5000 Storage system in my environment more frequently?

A4. The frequency of the discovery rule for the E5000/HP StoreEasy 5000 Storage system in OpsMgr can be changed with appropriate value. Follow the steps mentioned below:

1. Launch the OpsMgr console.
2. Navigate to Authoring pane, click **Object Discoveries**.
3. Search for the rule name **HP WMI Event Discovery Rule**.
4. Right click on the rule and select **Overrides > Override for the Object Discovery > For all the Object of the class: Windows Computer**.
5. Select the check mark corresponding to **Interval Seconds** and change the **Override Value** appropriately.

## HP StoreEver Tape Library

Q1. I am not able to see some events from the HP StoreEver Tape Libraries in the HP StoreEver Tape Libraries folder.

A1. It is an expected behavior. Open the HP Storage folder to see all the events from HP StoreEver Tape Library. These events come with source as "0".

## Miscellaneous

Q1. I have installed the HP Storage Management Pack for System Center for Microsoft Windows Server 2003 64-bit. However, I still get the error message 'The scripts required for this install to complete could not run'.

A1. Before installing the Storage Management Pack in Microsoft Windows Server 2003 for a 64-bit operating system, you must install a Microsoft Hotfix 942589 from Microsoft download site.

<http://support.microsoft.com/hotfix/KBHotfix.aspx?kbnum=942589&kbIn=en-us>



# 7 Support and other resources

## Intended audience

This guide is intended for administrators and users of HP storage products in a System Center Operations Manager environment. The readers of this document must be familiar with HP storage management software and the Microsoft Windows operating system.

## Related documentation

In addition to this guide, see the following websites:

- Other HP documents can be found at the following websites:  
<http://welcome.hp.com/country/us/en/support.html>  
<http://h18006.www1.hp.com/storage/>  
<http://docs.hp.com/en/storage.html>
- For HP 3PAR StoreServ Storage, see the website:  
<http://www8.hp.com/us/en/products/disk-storage/index.html>
- For HP StoreEver Tape Libraries, see the website:  
<http://www8.hp.com/us/en/products/tape-drives-enclosures/index.html>
- For troubleshooting on HP StoreEver Tape Libraries, see the HP Command View Tape Library software, see the website:  
<http://www.hp.com/support/cvtl>

## Document conventions and symbols

**Table 10 Document conventions and symbols**

Convention	Element
Medium blue text: Figure 1	Cross-reference links and e-mail addresses
Medium blue, underlined text ( <a href="http://www.hp.com">http://www.hp.com</a> )	Website addresses
<b>Bold font</b>	<ul style="list-style-type: none"><li>• Key names</li><li>• Text typed into a GUI element, such as into a box</li><li>• GUI elements that are clicked or selected, such as menu and list items, buttons, and check boxes</li></ul>
<i>Italics font</i>	Text emphasis
Monospace font	<ul style="list-style-type: none"><li>• File and directory names</li><li>• System output</li><li>• Code</li><li>• Text typed at the command line</li></ul>
Monospace, italic font	<ul style="list-style-type: none"><li>• Code variables</li><li>• Command-line variables</li></ul>
Monospace, bold font	Emphasis of file and directory names, system output, code, and text typed at the command line

---

❗ **IMPORTANT:** Provides information or specific instructions.

---

**NOTE:** Provides additional information.

---

💡 **TIP:** Provides helpful hints and shortcuts.

---

## HP technical support

Telephone numbers for worldwide technical support are listed on the HP support website:

<http://www.hp.com/support/>

Collect the following information before calling:

- Technical support registration number (if applicable)
- Product serial numbers
- Product model names and numbers
- Applicable error messages
- Operating system type and revision level
- Detailed, specific questions

For continuous quality improvement, calls may be recorded or monitored.

HP strongly recommends that customers sign up online using the Subscriber's choice website:

<http://www.hp.com/go/e-updates>

- Subscribing to this service provides you with e-mail updates on the latest product enhancements, newest versions of drivers, and firmware documentation updates as well as instant access to numerous other product resources.
- After signing up, you can quickly locate your products by selecting Business support and then Storage under Product Category.

## HP-authorized reseller

For the name of your nearest HP-authorized reseller:

- In the United States, call 1-800-282-6672.
- Elsewhere, visit the following HP website:

<http://www.hp.com>

Then click **Contact HP** to find locations and telephone numbers.

## Helpful websites

For other product information, see the following HP websites:

- <http://www.hp.com>
- <http://www.hp.com/go/storage>
- <http://www.hp.com/support/>
- <http://www.docs.hp.com>

## Support Information

Customers using HP Storage Management Pack for SCOM who have valid hardware array or software contracts can open a case with HP in one of two ways:

- Customers with an HP Microsoft Support contract may contact HP Software support by using the Service ID (SAID) associated with the CarePack they have purchased.
- Customers using SCOM with HP Arrays can open a case using either their serial number of the array or the SAID for the hardware Carepack they have purchased.

Cases can be opened in a number of ways which can be found on [www.hp.com](http://www.hp.com) by selecting your country and then **Customer Support**.

---

# Glossary

This glossary defines terms used in this guide or related to this product. It is not a comprehensive glossary of computer terms.

**OpsMgr:**

Microsoft System Center Operations Manager 2007 R2 or Microsoft System Center Operations Manager 2012 R2 enables you to monitor your IT services and provides an end-to-end monitoring environment.

**SNMP:**

Simple Network Management Protocol (SNMP) is a widely used network monitoring and control protocol. Data is passed from SNMP agents, which are hardware and/or software processes reporting activity in each network device (hub, router, bridge, and so on) to the workstation console used to oversee the network. The agents return information contained in an MIB (Management Information Base), which is a data structure that defines what is obtainable from the device and what can be controlled (turned off, on, and so on).

# Index

## A

- Alerts, 115
  - Views, 116
- Authorized reseller, 130

## C

- Conventions
  - document, 129

## D

- Document
  - conventions, , 129
- document
  - related documentation, , 129

## E

- E5000 Messaging System
  - understanding, 95
- Event Flow Model
  - WEBES, 7

## F

- Frequently Asked Questions, 121

## H

- help, 130
- Helpful websites, 130
- HP, 130
  - authorized reseller, 130
  - Subscriber's choice web site, 130
  - technical support, 130
- HP 3PAR StoreServ Storage
  - Diagram View, 51
  - Events\Alerts, 50
- HP E5000 Messaging System
  - Diagram View, 81
  - Events/Alerts, 80
- HP EVA P6000
  - Events/Alerts, 78
- HP P2000 MSA Storage
  - Diagram View, 68
  - Events/Alerts, 67
- HP StoreEasy 1000 and HP StoreEasy 3000 Storage
  - Events/Alerts, 75
- HP StoreEasy 5000 Storage
  - Diagram View, 73
  - Events/Alerts, 71
- HP StoreEver Tape Libraries
  - Events/Alerts, 82
- HP StoreOnce Backup
  - Events/Alerts, 78
- HP StoreVirtual Storage
  - Diagram View , 62
  - Events/Alerts, 62
- HP technical support, 130

- HP web site, 129
- HP XP 9000 Storage
  - Events/Alerts, 76

## I

- Insight Manager, 121
- Installing Management Pack, 11
- Installing Management Pack software, 15
- Installing OpsMgr, 12
- Installing SNMP, 13
- Installing WEBES/SEA, 14
- Installing WMI, 15
- Intended audience, 129

## K

- Known Behavior, 122

## M

- Management Pack
  - Disabling Discoveries, 109
  - Discovered Inventory, 105
  - Event handling, 113
  - Monitoring console, 113
  - Monitoring HP Services Health, 111
- Monitoring
  - SNMP, 84

## O

- OpsMgr Views, 114

## P

- Platform Support, 121
- Product support, 11

## R

- Related documentation, 129

## S

- SNMP, 84
- Subscriber's choice, 130
- Support and other resources, 129
- Support Information, 131
- System requirements
  - Support, 11

## T

- technical support, 130
- Traps, 84
- Troubleshooting, 122

## U

- Using SNMP, 8
- Using WMI, 9

## W

- web sites

- HP storage, [130](#)
- HP Subscriber's choice, [130](#)
- WEBES
  - monitoring, [91](#)
  - WEBES Listener, [8](#)
- WMI Events, [95](#)